



DLP® Projector

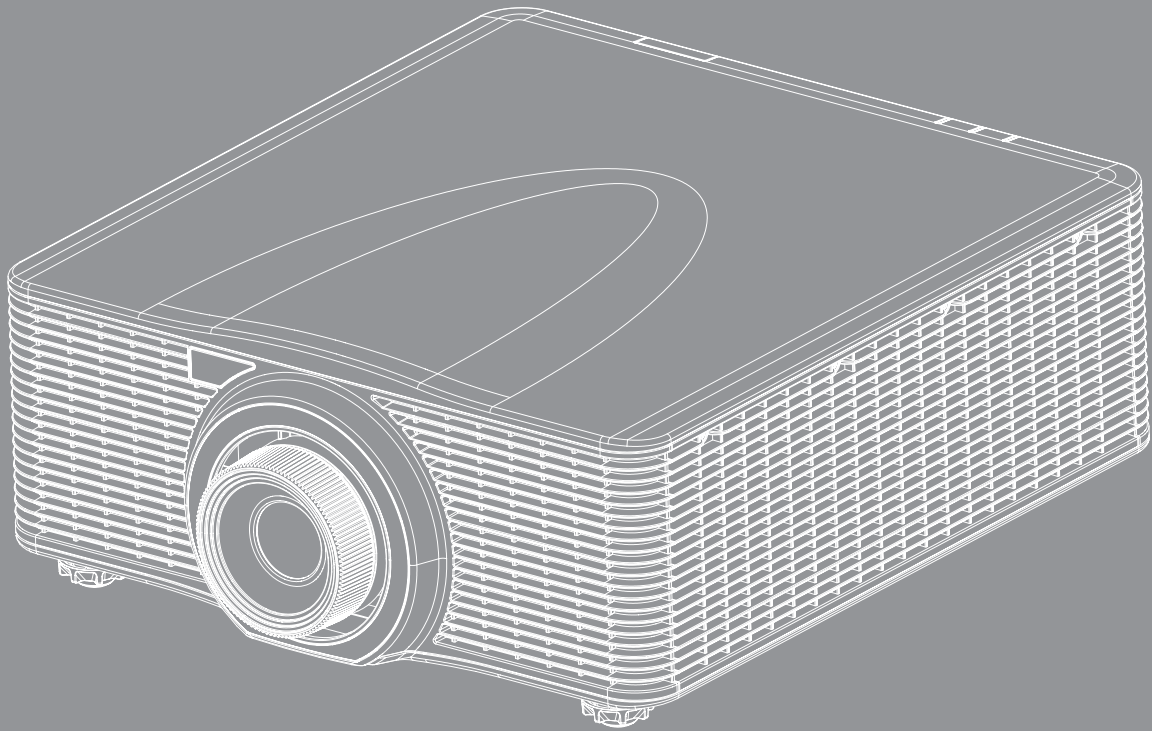

TABLE OF CONTENTS

SAFETY	4
<i>Important Safety Instruction.....</i>	<i>4</i>
<i>Laser Safety Cautions</i>	<i>5</i>
<i>Copyright</i>	<i>6</i>
<i>Disclaimer.....</i>	<i>6</i>
<i>Trademark Recognition</i>	<i>6</i>
<i>FCC</i>	<i>6</i>
<i>Declaration of Conformity for EU countries</i>	<i>7</i>
<i>WEEE.....</i>	<i>7</i>
INTRODUCTION	8
<i>Package Overview.....</i>	<i>8</i>
<i>Standard accessories</i>	<i>8</i>
<i>Optional accessories</i>	<i>8</i>
<i>Product Overview</i>	<i>9</i>
<i>Connections.....</i>	<i>10</i>
<i>Keypad</i>	<i>11</i>
<i>Remote control.....</i>	<i>12</i>
SETUP AND INSTALLATION	13
<i>Installing the projection lens</i>	<i>13</i>
<i>Adjusting the projector position</i>	<i>15</i>
<i>Connecting sources to the projector.....</i>	<i>16</i>
<i>Adjusting the projector image</i>	<i>17</i>
<i>Remote setup</i>	<i>18</i>
USING THE PROJECTOR.....	20
<i>Powering on / off the projector.....</i>	<i>20</i>
<i>Selecting an input source</i>	<i>21</i>
<i>Menu navigation and features</i>	<i>22</i>
<i>OSD Menu tree.....</i>	<i>23</i>
<i>DISPLAY menu.....</i>	<i>30</i>
<i>OUTPUT menu.....</i>	<i>35</i>
<i>SETUP menu.....</i>	<i>40</i>
<i>Setup network control settings menu</i>	<i>45</i>
<i>OPTION menu.....</i>	<i>50</i>

ADDITIONAL INFORMATION	53
<i>Compatible resolutions</i>	<i>53</i>
<i>Image size and projection distance</i>	<i>58</i>
<i>IR remote codes</i>	<i>60</i>
<i>Troubleshooting</i>	<i>63</i>
<i>Warning indicators</i>	<i>64</i>
<i>Specifications</i>	<i>66</i>
<i>Optoma global offices</i>	<i>67</i>

SAFETY

	The lightning flash with arrow head within an equilateral triangle is intended to alert the user to the presence of uninsulated "dangerous voltage" within the product's enclosure that may be of sufficient magnitude to constitute a risk of electric shock to persons.
	The exclamation point within an equilateral triangle is intended to alert the user to the presence of important operating and maintenance (servicing) instructions in the literature accompanying the appliance.

Please follow all warnings, precautions and maintenance as recommended in this user's guide.

Important Safety Instruction

- Do not block any ventilation openings. To ensure reliable operation of the projector and to protect from over heating, it is recommended to install the projector in a location that does not block ventilation. As an example, do not place the projector on a crowded coffee table, sofa, bed, etc. Do not put the projector in an enclosure such as a book case or a cabinet that restricts air flow.
- To reduce the risk of fire and/or electric shock, do not expose the projector to rain or moisture. Do not install near heat sources such as radiators, heaters, stoves or any other apparatus such as amplifiers that emits heat.
- Do not let objects or liquids enter the projector. They may touch dangerous voltage points and short out parts that could result in fire or electric shock.
- Do not use under the following conditions:
 - In extremely hot, cold or humid environments.
 - (i) Ensure that the ambient room temperature is within 5°C ~ 40°C
 - (ii) Relative humidity is 10% ~ 85%
 - In areas susceptible to excessive dust and dirt.
 - Near any appliance generating a strong magnetic field.
 - In direct sunlight.
- Do not use the projector in places where flammable gases or explosives gases may be present in the atmosphere. The lamp inside the projector becomes very hot during operation and the gases may ignite and result in a fire.
- Do not use the unit if it has been physically damaged or abused. Physical damage/abuse would be (but not limited to):
 - Unit has been dropped.
 - Power supply cord or plug has been damaged.
 - Liquid has been spilled on to the projector.
 - Projector has been exposed to rain or moisture.
 - Something has fallen in the projector or something is loose inside.
- Do not place the projector on an unstable surface. The projector may fall over resulting in injury or the projector may become damaged.
- Do not block the light coming out of the projector lens when in operation. The light will heat the object and may melt, cause burns or start a fire.
- Please do not open or disassemble the projector as this may cause electric shock.
- Do not attempt to service the unit yourself. Opening or removing covers may expose you to dangerous voltages or other hazards. Please call Optoma before you send the unit for repair.
- See projector enclosure for safety related markings.
- The unit should only be repaired by authorized service personnel.

- Only use attachments/accessories specified by the manufacturer.
- Do not look into straight into the projector lens during operation. The bright light may harm your eyes.
- This projector will detect the life of the lamp itself.
- When switching the projector off, please ensure the cooling cycle has been completed before disconnecting power. Allow 90 seconds for the projector to cool down.
- Turn off and unplug the power plug from the AC outlet before cleaning the product.
- Use a soft dry cloth with mild detergent to clean the display housing. Do not use abrasive cleaners, waxes or solvents to clean the unit.
- Disconnect the power plug from AC outlet if the product is not being used for a long period of time.
- Do not setup the projector in places where it might be subjected to vibration or shock.
- Do not touch the lens with bare hands.
- Remove battery/batteries from remote control before storage. If the battery/batteries are left in the remote for long periods, they may leak.
- Do not use or store the projector in places where smoke from oil or cigarettes may be present, as it can adversely affect the quality of the projector performance.
- Please follow the correct projector orientation installation as non standard installation may affect the projector performance.
- Use a power strip and or surge protector. As power outages and brown-outs can KILL devices.

Laser Safety Cautions

This product is classified as CLASS 1 LASER PRODUCT - RISK GROUP 2 of IEC 60825-1:2014 and also complies with 21 CFR 1040.10 and 1040.11 as a Risk Group 2, LIP (Laser Illuminated Projector) as defined in IEC 62471:2006 except for deviations pursuant to Laser Notice No. 50, dated June 24, 2007.

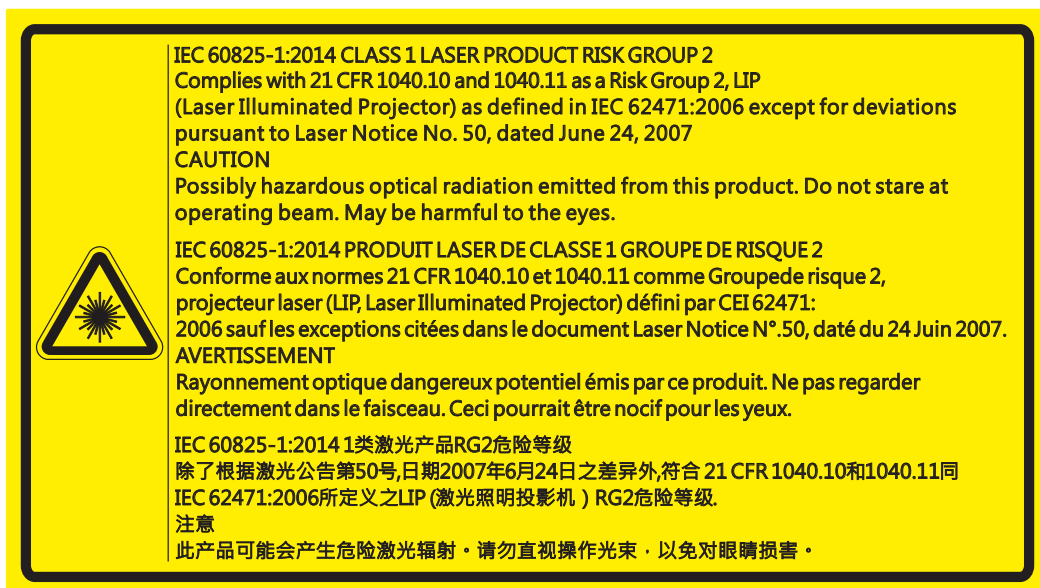

- This projector has built-in Class 4 laser module. Disassembly or modification is very dangerous and should never be attempted.
- Any operation or adjustment not specifically instructed in the user's guide creates the risk of hazardous laser radiation exposure.
- Do not open or disassemble the projector as this may cause damage by the exposure of laser radiation.
- Do not stare into beam when the projector is on. The bright light may result in permanent eye damage.
- When turning on the projector, make sure no one within projection range is looking at the lens.
- Without following the control, adjustment or operation procedure may cause damage by the exposure of laser radiation.
- Adequate instructions for the assembly, operation, and maintenance, including clear warnings concerning precautions to avoid possible exposure to laser.

Copyright

This publication, including all photographs, illustrations and software, is protected under international copyright laws, with all rights reserved. Neither this manual, nor any of the material contained herein, may be reproduced without written consent of the author.

© Copyright 2017

Disclaimer

The information in this document is subject to change without notice. The manufacturer makes no representations or warranties with respect to the contents hereof and specifically disclaims any implied warranties of merchantability or fitness for any particular purpose. The manufacturer reserves the right to revise this publication and to make changes from time to time in the content hereof without obligation of the manufacturer to notify any person of such revision or changes.

Trademark Recognition

Kensington is a U.S. registered trademark of ACCO Brand Corporation with issued registrations and pending applications in other countries throughout the world.

HDMI, the HDMI Logo, and High-Definition Multimedia Interface are trademarks or registered trademarks of HDMI Licensing LLC in the United States and other countries.

DLP®, DLP Link and the DLP logo are registered trademarks of Texas Instruments and BrilliantColor™ is a trademark of Texas Instruments.

All other product names used in this manual are the properties of their respective owners and are Acknowledged.

FCC

This device has been tested and found to comply with the limits for a Class A digital device pursuant to Part 15 of the FCC rules. These limits are designed to provide reasonable protection against harmful interference in a residential installation. This device generates, uses and can radiate radio frequency energy and, if not installed and used in accordance with the instructions, may cause harmful interference to radio communications.

However, there is no guarantee that interference will not occur in a particular installation. If this device does cause harmful interference to radio or television reception, which can be determined by turning the device off and on is encouraged to try to correct the interference by one or more of the following measures:

- Reorient or relocate the receiving antenna.
- Increase the separation between the device and receiver.
- Connect the device into an outlet on a circuit different from that to which the receiver is connected.
- Consult the dealer or an experienced radio/television technician for help.

Notice: Shielded cables

All connections to other computing devices must be made using shielded cables to maintain compliance with FCC regulations.

Caution

Changes or modifications not expressly approved by the manufacturer could void the user's authority, which is granted by the Federal Communications Commission, to operate this projector.

Operation Conditions

This device complies with Part 15 of the FCC Rules. Operation is subject to the following two conditions:

1. This device may not cause harmful interference and
2. This device must accept any interference received, including interference that may cause undesired operation.

Notice: Canadian users

This Class A digital apparatus complies with Canadian ICES-003.

Remarque à l'intention des utilisateurs canadiens

Cet appareil numérique de la classe A est conforme à la norme NMB-003 du Canada.

Declaration of Conformity for EU countries

- EMC Directive 2014/30/EU
- Low Voltage Directive 2014/35/EU
- Radio Equipment Directive 2014/53/EU (if product has RF function)
- RoHS Directive 2011/65/EU

WEEE**Disposal instructions**

Do not throw this electronic device into the trash when discarding. To minimize pollution and ensure utmost protection of the global environment, please recycle it.

INTRODUCTION

Package Overview

Carefully unpack and verify that you have the items listed below under standard accessories. Some of the items under optional accessories may not be available depending on the model, specification and your region of purchase. Please check with your place of purchase. Some accessories may vary from region to region.

The warranty card is only supplied in some specific regions. Please consult your dealer for detailed information.

Standard accessories

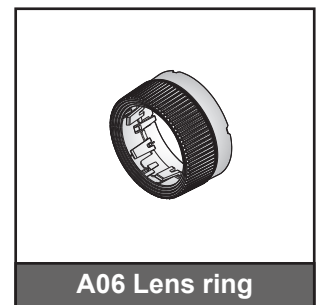
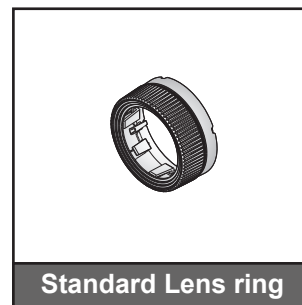
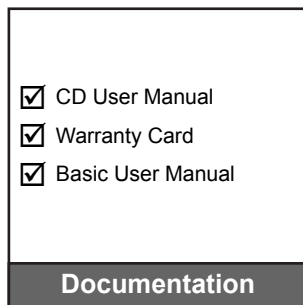
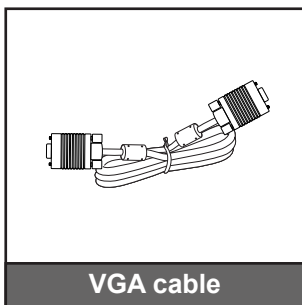
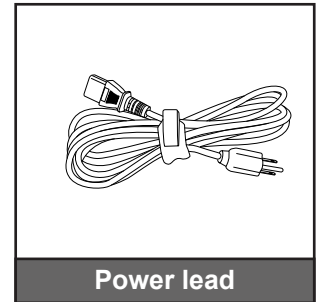
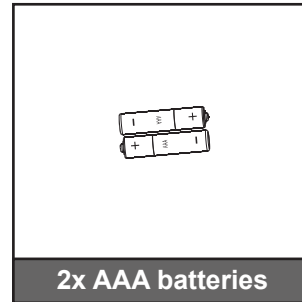
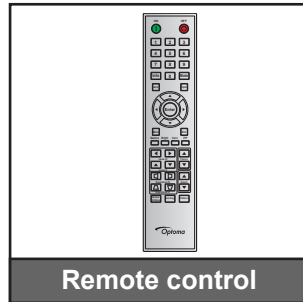
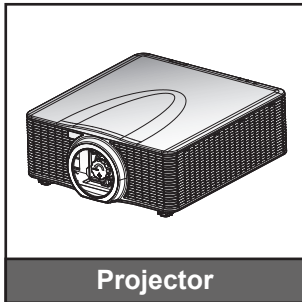

Optional accessories

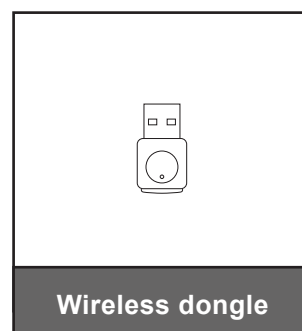
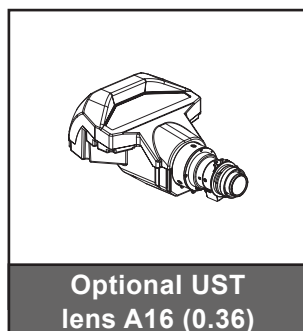
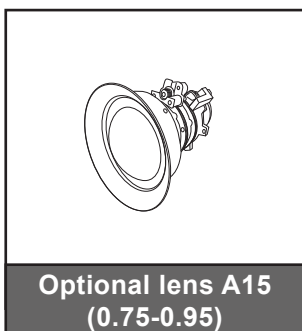
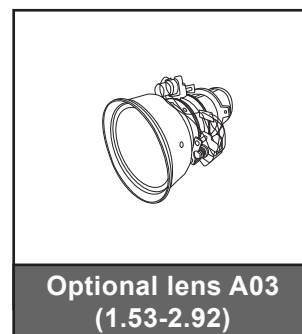
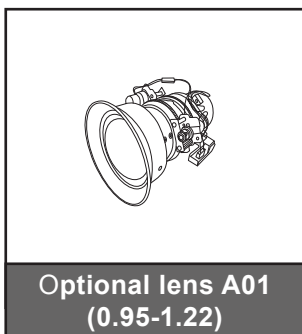

Note: Optional accessories vary depending on model, specification and region.

INTRODUCTION

Product Overview

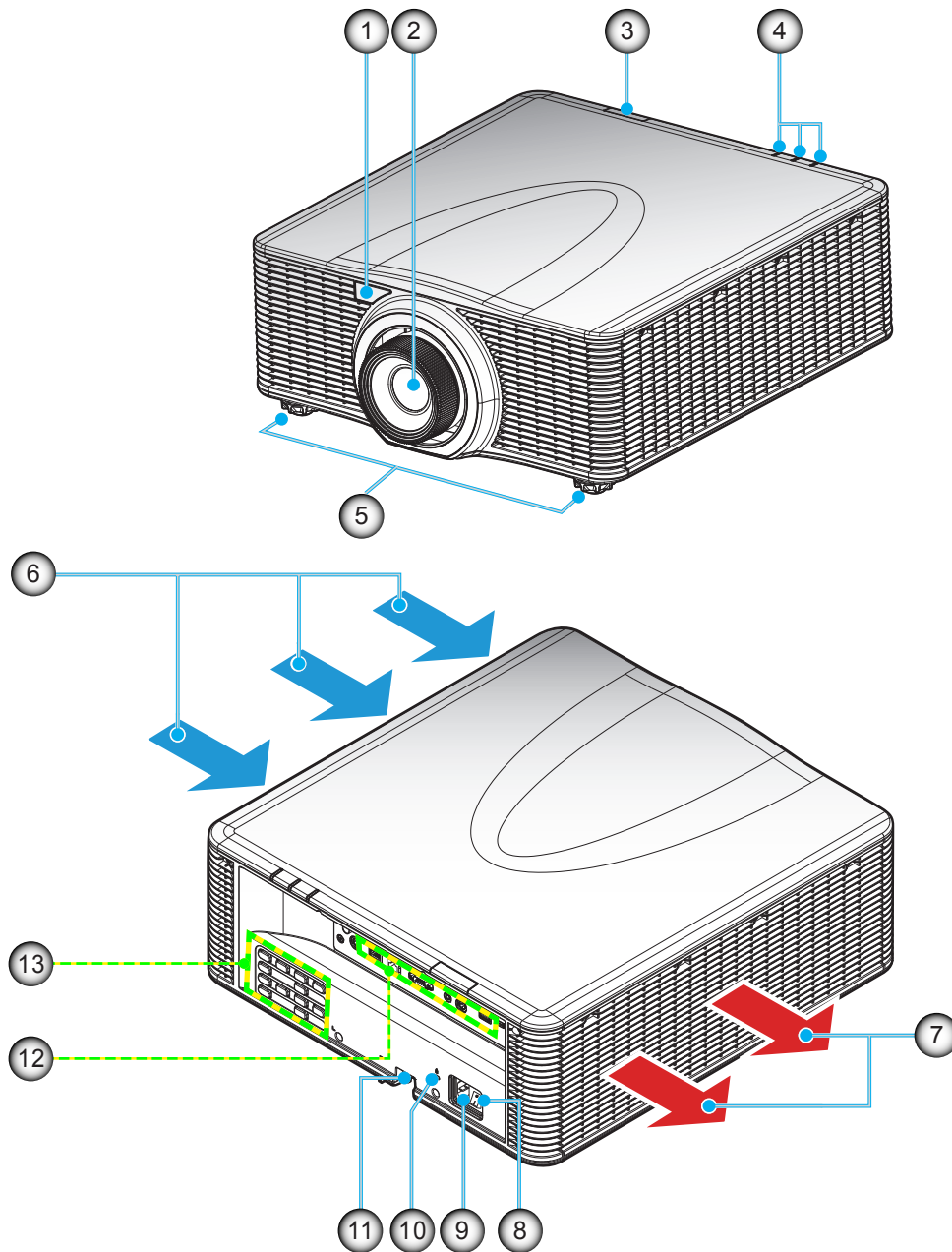

Note: Do not block projector inlet or outlet air vents.

(*) optional accessory varies depending on model, specification, and region.

No	Item	No	Item
1.	Front IR Receiver	8.	Power Switch
2.	Lens	9.	Power Socket
3.	Top IR Receiver	10.	Kensington™ Lock Port
4.	LED Status Indicators	11.	Security Bar
5.	Tilt-Adjustment Feet	12.	Input / Output
6.	Ventilation (inlet)	13.	Keypad
7.	Ventilation (outlet)		

INTRODUCTION

Connections

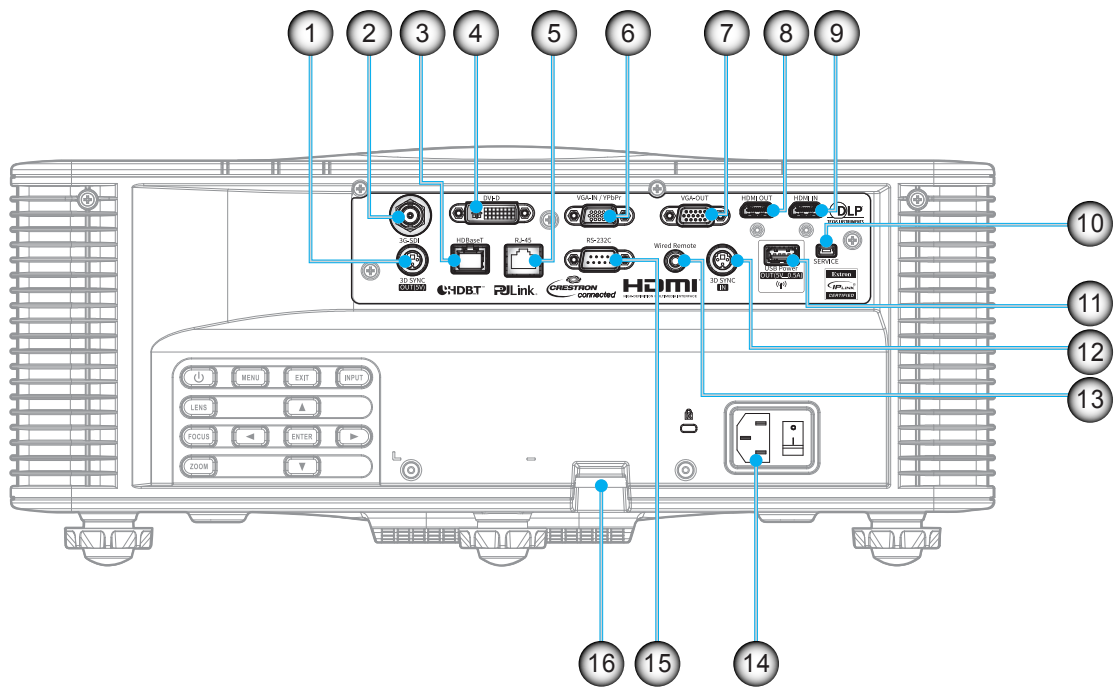

No	Item	No	Item
1.	3D SYNC OUT Connector	9.	HDMI IN Connector
2.	3G-SDI Connector	10.	SERVICE Connector
3.	HDBaseT Connector	11.	USB Connector (support 5V, 0.5A) for wireless dongle
4.	DVI-D Connector	12.	3D SYNC IN Connector
5.	LAN Connector	13.	Wired Remote Connector
6.	VGA IN Connector	14.	Power Socket
7.	VGA OUT Connector	15.	RS-232C Connector
8.	HDMI OUT Connector	16.	Security Bar

INTRODUCTION

Keypad

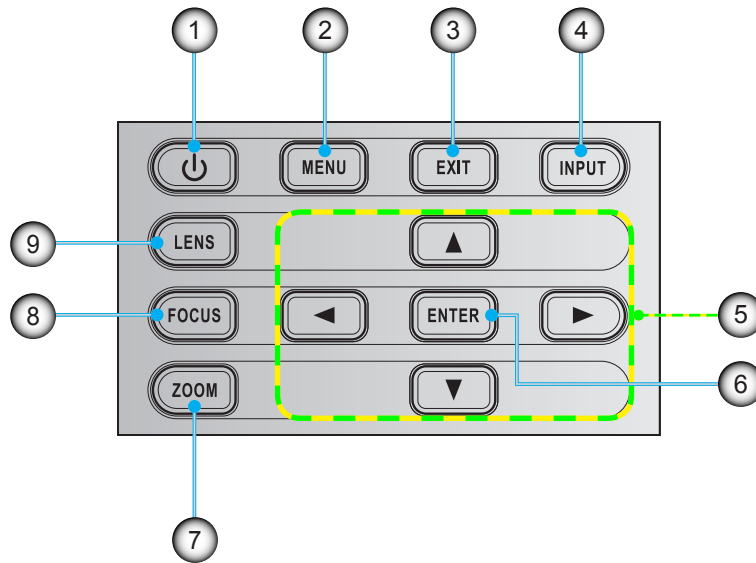

No	Item	No	Item
1.	Power	6.	Enter
2.	Menu	7.	Zoom
3.	Exit	8.	Focus
4.	Input	9.	Lens
5.	Four Directional Select Keys		

INTRODUCTION

Remote control

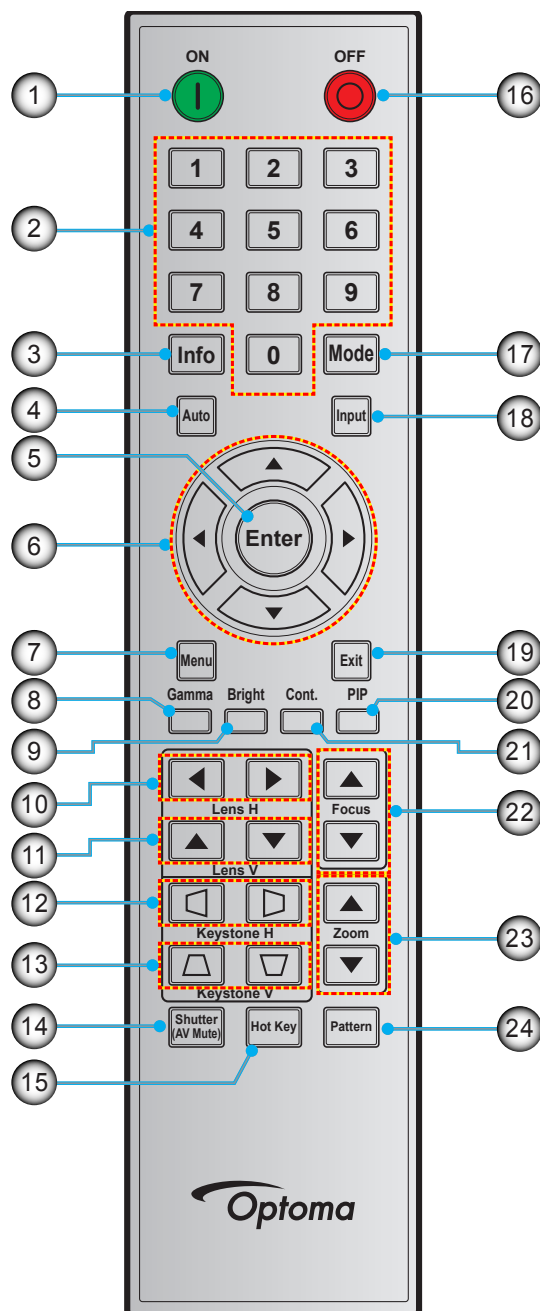

No	Item	No	Item	No	Item
1.	Power On	9.	Bright	17.	Mode
2.	Number Keys	10.	Lens H	18.	Input
3.	Info	11.	Lens V	19.	Exit
4.	Auto	12.	Keystone H	20.	PIP
5.	Enter	13.	Keystone V	21.	Cont.
6.	Four Directional Select Keys	14.	Shutter (AV Mute)	22.	Focus
7.	Menu	15.	Hot Key	23.	Zoom
8.	Gamma	16.	Power Off	24.	Pattern

SETUP AND INSTALLATION

Installing the projection lens

Before setting up the projector, install the projection lens on the projector.

在安装或替换镜头前，关掉投影机的电源。

在镜头安装联接过程中，避免使用遥控器或投影机按键板的按钮调节侧平移镜头或缩放/聚焦。

Before install or replacing the lens, switch off the power to the projector.

Avoid using the remote control or projector keypad button to adjust the lens shift or zoom/focus while the lens attachment process is carried out.

IMPORTANT!

- *Make sure the projector is properly turned off before installing the lens.*
- *During lens installation, do not adjust the lens shift, zoom, or focus either using the remote control or the projector keypad.*

Procedure:

1. Rotate the lens cap counterclockwise.

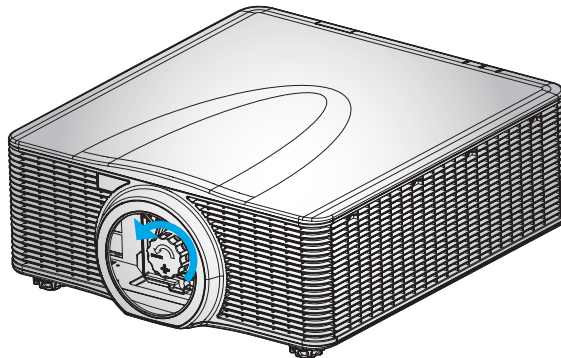

2. Remove the lens cap.

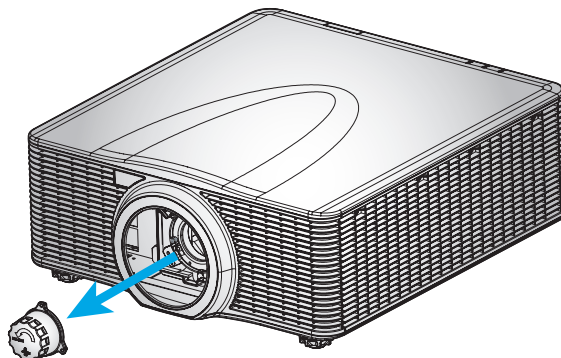

SETUP AND INSTALLATION

3. Install the lens onto the projector.

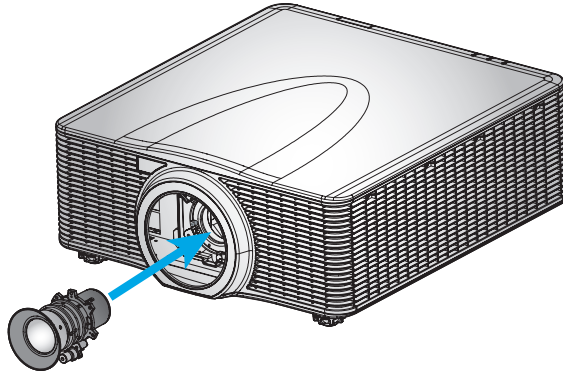

4. Rotate the lens clockwise to lock the lens in place.

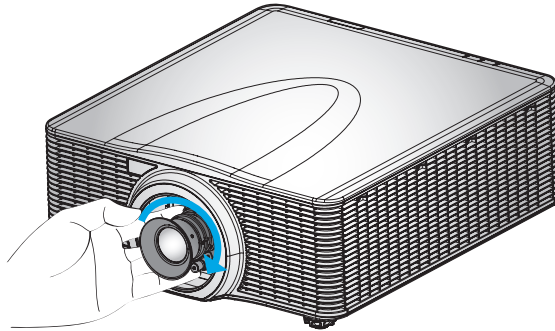

5. Firmly install the lens ring onto the lens.

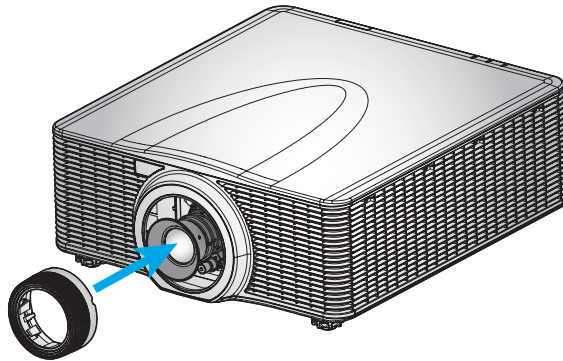

Note:

- *The lens rings are compatible with the following lens modules: A01 (0.95-1.22), A06 (1.22-1.52), A03 (1.53-2.92), and A13 (2.90-5.50).*
- *For A16 UST Lens installation, please check the exclusive manual bundled within A16.*

SETUP AND INSTALLATION

Adjusting the projector position

When you select a position for the projector, consider the size and shape of your screen, the location of your power outlets, and the distance between the projector and the rest of your equipment. Follow these general guidelines:

- Position the projector on a flat surface at a right angle to the screen. The projector (with the standard lens) must be at least 3 feet (0.9m) from the projection screen.
- Position the projector to the desired distance from the screen. The distance from the lens of the projector to the screen, the zoom setting, and the video format determine the size of the projected image.
- For the fixed short lens, the image exits at a default angle. However, the lens shift feature makes the image offset variable.
- 360 degree free orientation operation

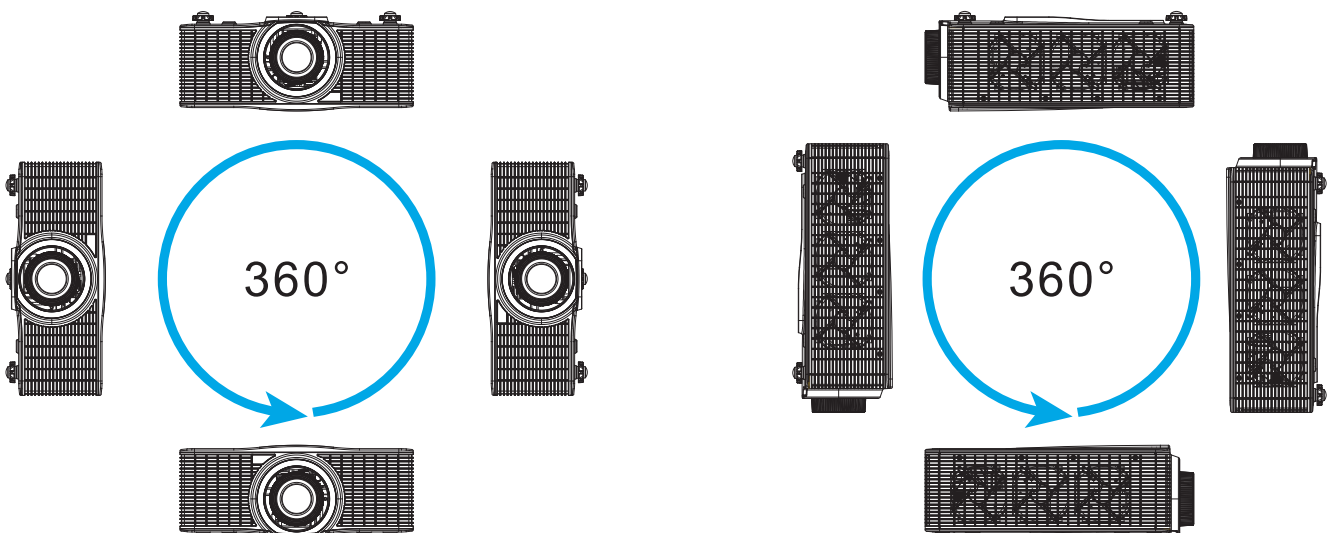

SETUP AND INSTALLATION

Connecting sources to the projector

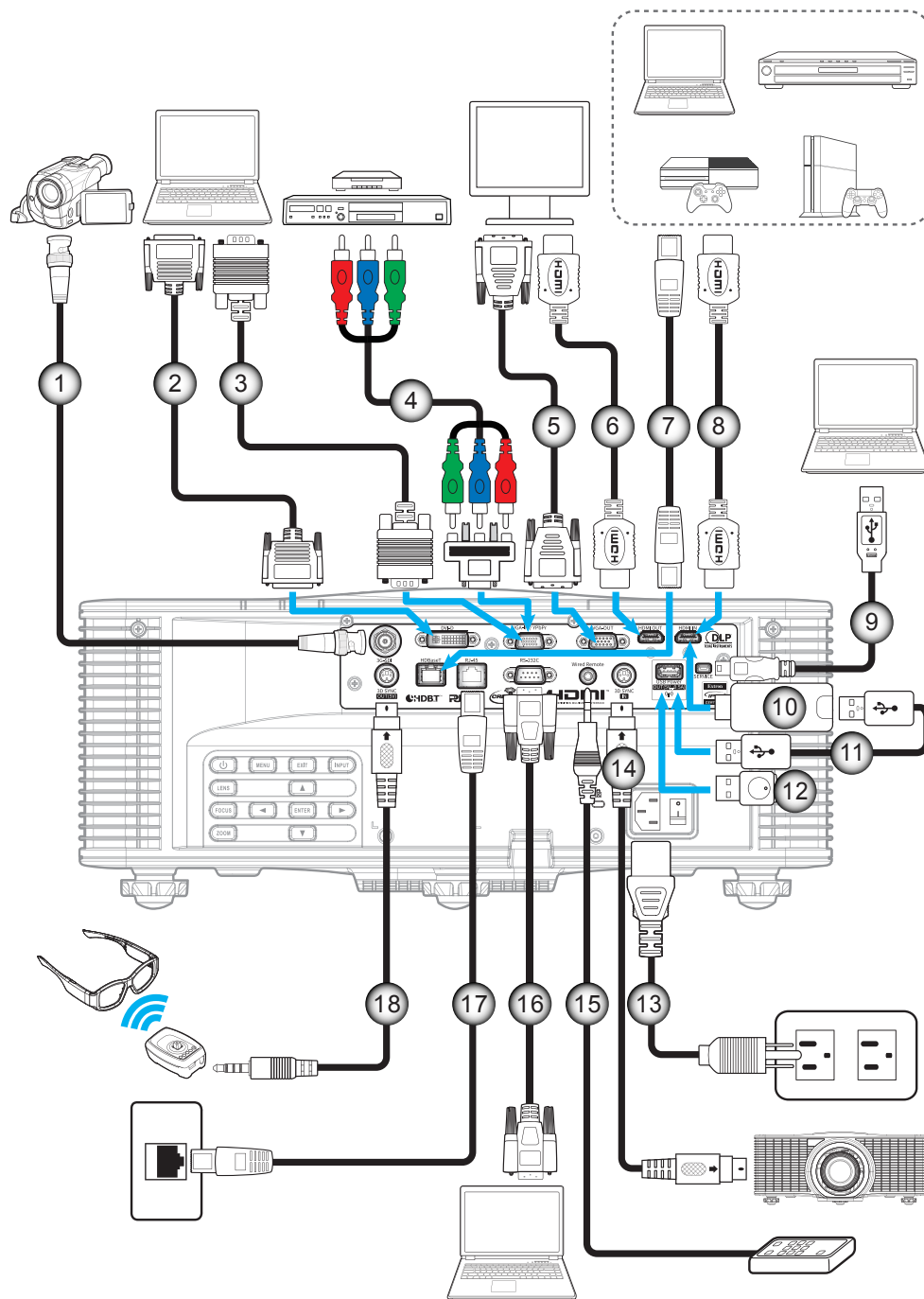

No	Item	No	Item
1.	BNC Cable	10.	HDMI Dongle
2.	DVI-D Cable	11.	USB Power Cable
3.	VGA-In Cable	12.	Wireless (Wi-Fi) Dongle
4.	RCA Component Cable	13.	Power Cord
5.	VGA-Out Cable	14.	3D Sync In Cable
6.	HDMI Cable	15.	Wired Remote-In Cable (~30m)
7.	CAT5e/6/6A Cable	16.	RS-232C Cable
8.	HDMI Cable	17.	RJ-45 Cable
9.	USB Cable (mouse control)	18.	3D Emitter Cable

SETUP AND INSTALLATION

Adjusting the projector image

Image height

The projector is equipped with elevator feet for adjusting the image height.

1. Locate the adjustable foot you wish to adjust on the underside of the projector.
2. Rotate the adjustable foot clockwise or counterclockwise to raise or lower the projector.

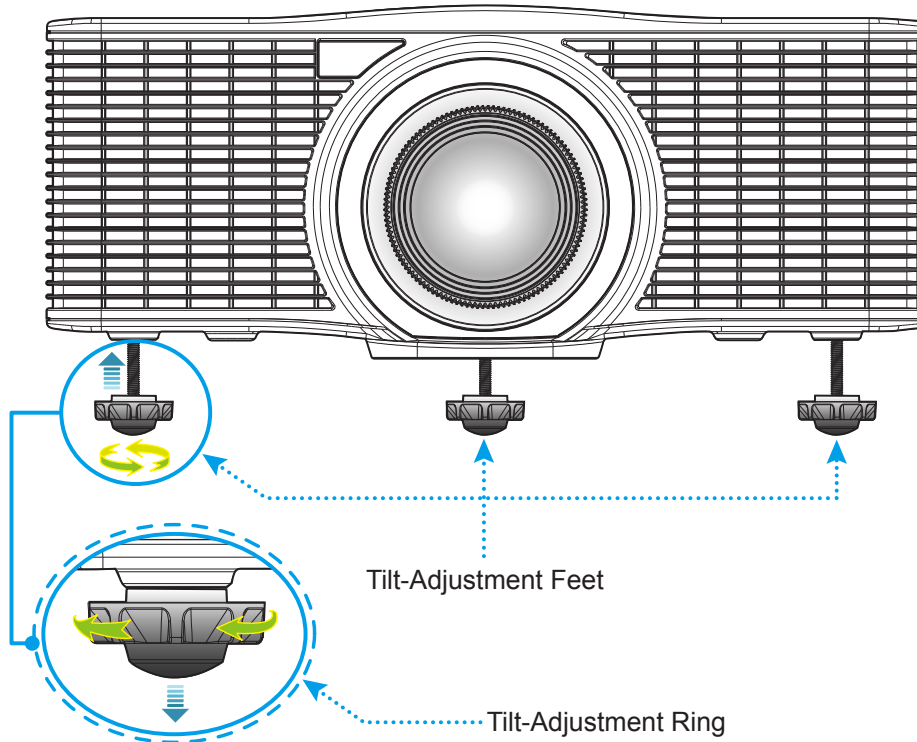

Warning:

- The feet of projector are not removable. Please do not screw out the feet of projector. The adjustable height of the elevator feet could be raised up to 45mm.

Zoom and focus

- To adjust the image size, press the **Zoom** button (A) to increase or decrease the projected image size.
- To adjust the focus, press the **Focus** button (B) until the image is sharp and legible.

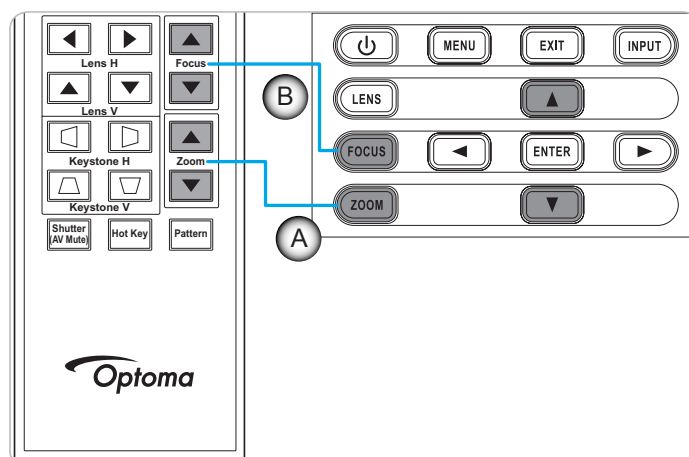

SETUP AND INSTALLATION

Remote setup

Installing / replacing the batteries

Two AAA size batteries are supplied for the remote control.

1. Remove the battery cover on the back of the remote control.
2. Insert AAA batteries in the battery compartment as illustrated.
3. Replace back cover on remote control.

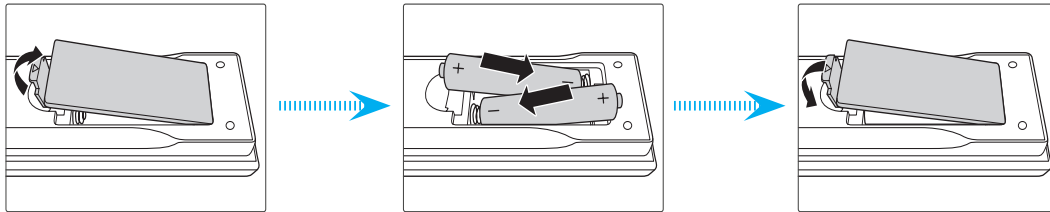

Note: Replace only with the same or equivalent type batteries.

CAUTION

Improper use of batteries can result in chemical leakage or explosion. Be sure to follow the instructions below.

- Do not mix batteries of different types. Different types of batteries have different characteristics.
- Do not mix old and new batteries. Mixing old and new batteries can shorten the life of new batteries or cause chemical leakage in old batteries.
- Remove batteries as soon as they are depleted. Chemicals that leak from batteries that come in contact with skin can cause a rash. If you find any chemical leakage, wipe thoroughly with a cloth.
- The batteries supplied with this product may have a shorter life expectancy due to storage conditions.
- If you will not be using the remote control for an extended period of time, remove the batteries.
- When you dispose of the batteries, you must obey the law in the relative area or country.

Effective range

Infra-Red (IR) remote control sensors are located on the front and top sides of the projector. Ensure to hold the remote control at an angle within $\pm 30^\circ$ (horizontally or vertically) to the projector's IR remote control sensor to function correctly. The distance between the remote control and the sensor should not be longer than 10 meters (32.8 feet).

- Make sure that there are no obstacles between the remote control and the IR sensor on the projector that might obstruct the infra-red beam.
- Make sure the IR transmitter of the remote control is not being shined by sunlight or fluorescent lamps directly.
- Please keep the remote controller away from fluorescent lamps for over 2 m or the remote controller might become malfunction.
- If the remote control is closed to Inverter-Type fluorescent lamps, it might become ineffective from time to time.
- If the remote control and the projector are within a very short distance, the remote control might become ineffective.
- When you aim at the screen, the effective distance is less than 5 m from the remote control to the screen and reflecting the IR beams back to the projector. However, the effective range might change according to screens.

SETUP AND INSTALLATION

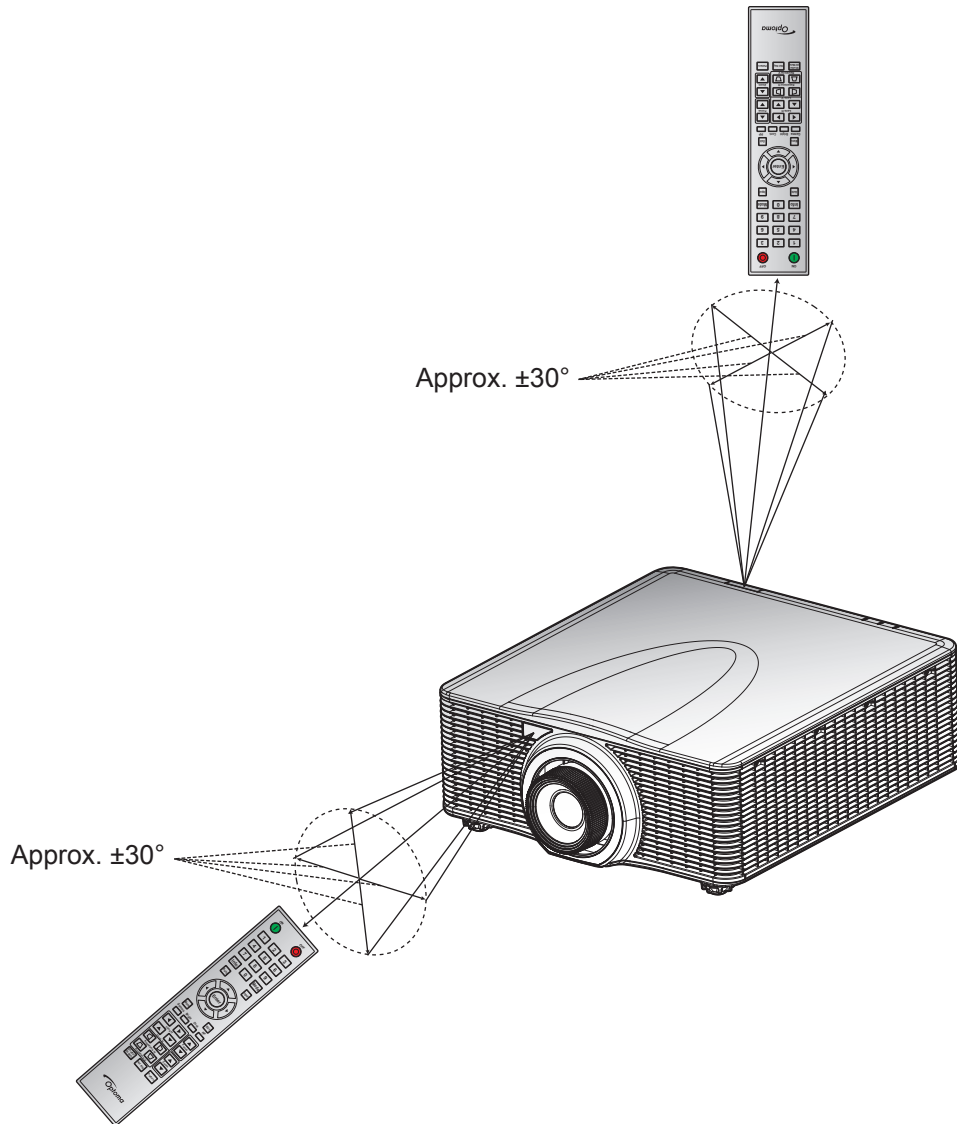

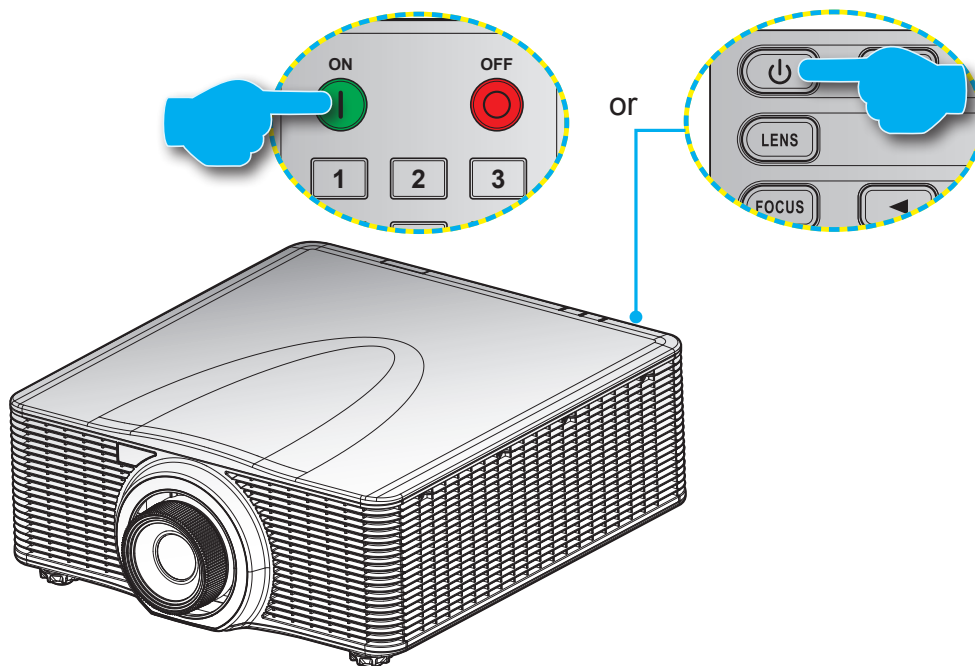

USING THE PROJECTOR

Powering on / off the projector





Powering on





1. Securely connect the power lead and signal/source cable.
2. Set the **Power** switch to the “ON” position.
3. Turn on the projector by pressing “” on the remote control or pressing “” on the projector keypad. The Status LED is Orange with a long blink.

Note: The first time the projector is turned on, you will be prompted to select the preferred language, projection orientation, and other settings.

Powering off

1. Turn off the projector by pressing “” on the projector keypad or pressing “” on the remote control. A warning message will appear on the displayed image.

Powering Off...
Press OFF key to Confirm

2. Press “” on the projector keypad or press “” on the remote control again to confirm, otherwise the warning message will disappear after 10 seconds. When you press “” on the projector keypad or press “” on the remote control for the second time, the projector will shut down.
3. Set the **Power** switch to the “OFF” position.
4. Disconnect the power lead from the electrical outlet and the projector.

Note: It is not recommended that the projector is turned on immediately, right after a power off procedure.

USING THE PROJECTOR

Selecting an input source

Turn on the connected source that you want to display on the screen, such as computer, notebook, video player, etc. The projector will automatically detect the source. If multiple sources are connected, press the **Input** button on the projector keypad or the remote control to select the desired input.

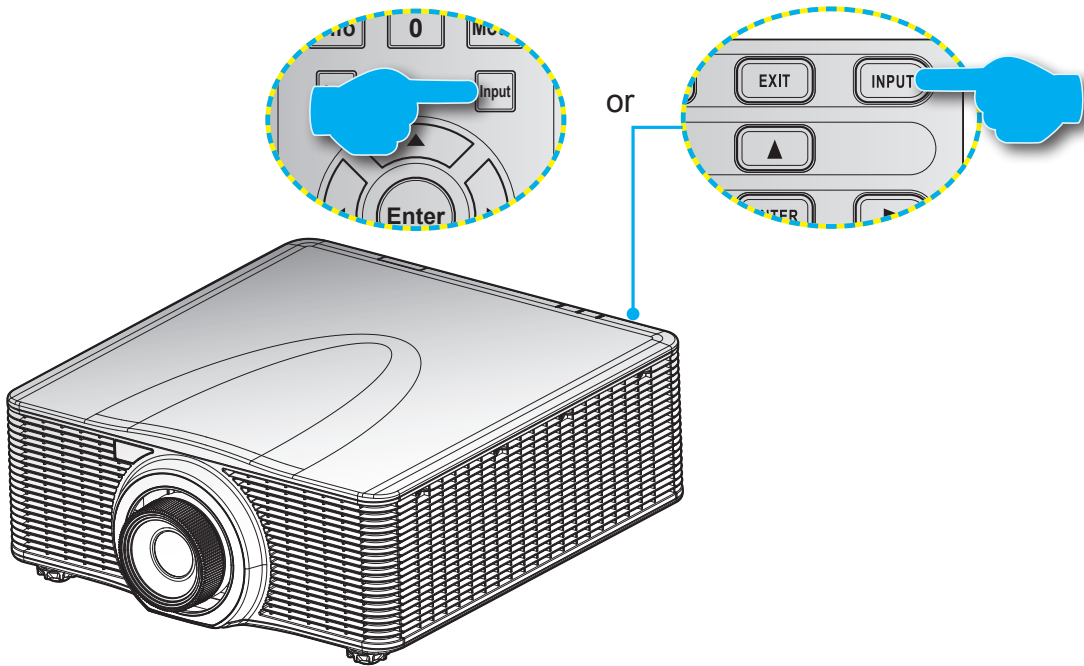

USING THE PROJECTOR

Menu navigation and features

The projector has multilingual on-screen display menus that allow you to make image adjustments and change a variety of settings. The projector will automatically detect the source.

1. To open the OSD menu, press "Menu" on the remote control or the projector keypad.
2. When OSD is displayed, use ▲▼◀▶ to navigate within the menu and adjust a setting up or down.
3. Press "Enter" to enter the submenu or confirm the selection/setting.
4. Press "Exit" to return to the previous menu or exit menus if at top level.

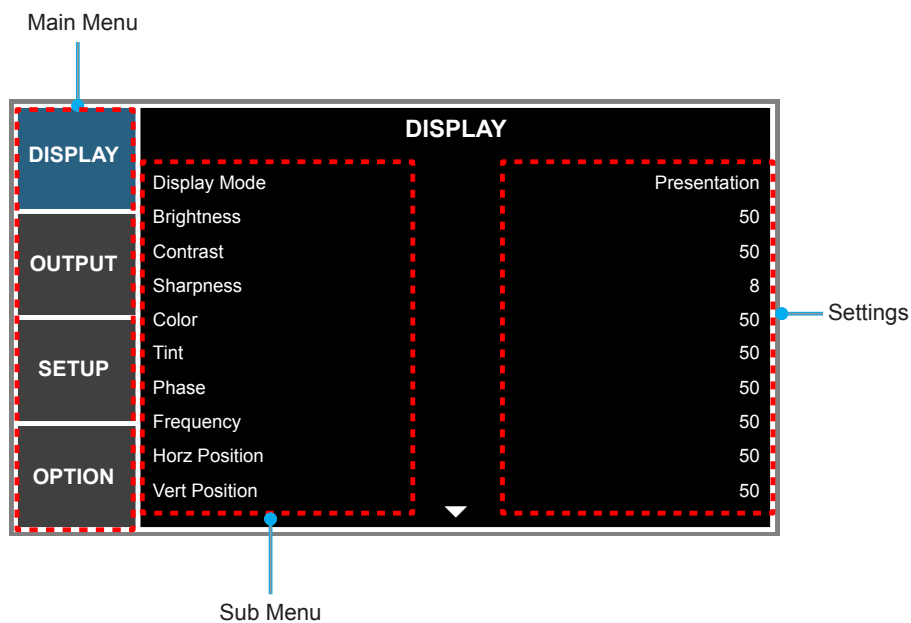

USING THE PROJECTOR

OSD Menu tree

Main Menu	Sub Menu	Sub Menu 2	Sub Menu 3	Sub Menu 4	Values	
DISPLAY	Display Mode	Presentation			By source set	
		Movie				
		Bright				
		REC709				
		DICOM SIM				
		2D High Speed				
		3D				
		Blending				
		User				
		Save to User				
	Brightness	0 ~ 100			By source set	
	Contrast	0 ~ 100			By source set	
	Sharpness	0 ~ 8			By source set	
	Color	0 ~ 100			By source set	
	Tint	0 ~ 100			By source set	
	Phase	0 ~ 100			By source set	
	Frequency	0 ~ 100			By source set	
	Horz Position	0 ~ 100			By source set	
	Vert Position	0 ~ 100			By source set	
	3D	3D Format	Auto			Auto
			Frame Packing			
			Side by Side			
			Top and Bottom			
			Frame Sequential			
			Off			
		3D Invert	Off			Off
			On			
		DLP Link	Off			On
			On			
	3D Sync Out	To Emitter			To Emitter	
		To Next Projector				
	Frame Delay	1~ n (by timing,Max 200)			61	
Color Matching	HSG Enable	Off			Color Enhancement 1	
		Color Enhancement 1				
		Color Enhancement 2				
		User				
	Auto Test Pattern	Off			On	
		On				
	Red H.	0 – 254			127	
	Red S.	0 – 254			127	
Red G.	0 – 254			127		
Green H.	0 – 254			127		

USING THE PROJECTOR

Main Menu	Sub Menu	Sub Menu 2	Sub Menu 3	Sub Menu 4	Values	
DISPLAY	Color Matching	Green S.	0 – 254		127	
		Green G.	0 – 254		127	
		Blue H.	0 – 254		127	
		Blue S.	0 – 254		127	
		Blue G.	0 – 254		127	
		Cyan H.	0 – 254		127	
		Cyan S.	0 – 254		127	
		Cyan G.	0 – 254		127	
		Magenta H.	0 – 254		127	
		Magenta S.	0 – 254		127	
		Magenta G.	0 – 254		127	
		Yellow H.	0 – 254		127	
		Yellow S.	0 – 254		127	
		Yellow G.	0 – 254		127	
		White R Gain	0 – 254		127	
		White G Gain	0 – 254		127	
		White B Gain	0 – 254		127	
		Reset to Default	No			No
	Yes					
	Advanced	White Peaking	0 - 100			By source set
		Gamma	Video			By source set
			Film			
			Blackboard			
			Graphic			
			DICOM			
			Gamma 2.2			
		Color Temperature	Warm			By source set
			Medium			
			Cool			
			Cold			
		Color Space	RGB			Auto
			REC709			
			REC601			
			RGB Video			
			Auto			
		RGB Gain/Bias	Red Gain	0 ~ 100		50
			Green Gain	0 ~ 100		50
Blue Gain			0 ~ 100		50	
Red Offset			0 ~ 100		50	
Green Offset	0 ~ 100			50		
Blue Offset	0 ~ 100			50		
Reset RGB Gain/Offset						
Color Wheel Speed	2X			2X		
	3X					
Film Mode	Off			Off		
	On					

USING THE PROJECTOR

Main Menu	Sub Menu	Sub Menu 2	Sub Menu 3	Sub Menu 4	Values		
DISPLAY	Advanced	Extreme Black	Off		Off		
			On				
		Dynamic Black	Off		Off		
			On				
OUTPUT	Aspect Ratio	Auto			Auto		
		4:3					
		16:9					
		16:10					
		Native					
	Overscan	Off			By source set		
		Zoom					
		Crop					
	H Digital Zoom	50% ~ 400%			100		
	V Digital Zoom	50% ~ 400%			100		
	H Digital Shift	0 ~ 100			50		
	V Digital Shift	0 ~ 100			50		
	Image Warping	PC Mode	Off			Off	
			On				
		H Keystone	0 ~ 40			20	
		V Keystone	0 ~ 40			20	
		H Pincushion	0 ~ 100			50	
		V Pincushion	0 ~ 100			50	
		4-Corner	Top Left Corner Adjust			0(Horz)	
						0(Vert)	
			Top Right Corner Adjust			0(Horz)	
						0(Vert)	
			Bottom Left Corner Adjust			0(Horz)	
		Bottom Right Corner Adjust			0(Vert)		
		Reset to Dafault					
		PIP/PBP Settings	PIP/PBP Function	Off			Off
				On			
	Main Source		VGA			VGA	
			HDMI				
			DVI-D				
			HDBaseT				
			Network Display				
3G-SDI							
Sub Source	VGA						
	HDMI						
	DVI-D						
	HDBaseT						
	Network Display						
	3G-SDI						

USING THE PROJECTOR

Main Menu	Sub Menu	Sub Menu 2	Sub Menu 3	Sub Menu 4	Values
OUTPUT	PIP/PBP Settings	Swap			
		Size	Small		Large
			Medium		
			Large		
		Layout	PBP, Main Left		PBP, Main Left
			PBP, Main Top		
			PBP, Main Right		
			PBP, Main Bottom		
			PIP-Bottom Right		
			PIP-Bottom Left		
PIP-Top Left					
PIP-Top Right					
SETUP	Language	English		English	
		French			
		Spanish			
		German			
		Italian			
		Russian			
		Chinese Simplified			
		Japanese			
		Korean			
		Portuguese			
		Indonesian			
	Dutch				
	Ceiling Mount	Off		Auto	
		On			
		Auto			
	Rear Projection	Off		Off	
		On			
	Lens Settings	Focus	Focus in - motor go step		
			Focus out - motor go step		
		Zoom	Zoom in - motor go step		
			Zoom out - motor go step		
		Lens Shift	Left shift up - motor go step		
			Left shift down - motor go step		
			Left shift right - motor go step		
			Left shift left - motor go step		

USING THE PROJECTOR

Main Menu	Sub Menu	Sub Menu 2	Sub Menu 3	Sub Menu 4	Values	
SETUP	Lens Settings	Lens Calibration	No			
			Yes			
		Lens Memory	Apply Position	1		
				2		
				3		
				4		
				5		
			Save Current Position	1		
				2		
				3		
				4		
				5		
	Lens Lock	No		No		
		Yes				
	Menu Settings	Menu Transparency	0 ~ 9		0	
		Information Hide	Off		Off	
			On			
	Keypad LED Settings	Off			On	
		On				
	Security	Password	Off		Off	
			On			
		Change Password				
	Communications	LAN	DHCP	Off		by set
				On		
			IP Address		by set	
			Subnet Mask		by set	
			Gateway		by set	
			MAC Address		by set	
			Apply			
		WLAN	Enable		by set	
			Start IP		by set	
			End IP		by set	
			Subnet Mask		by set	
			Gateway		by set	
			MAC Address		by set	
			SSID		by set	
		Network	Projector Name		by set	
			Restart Network			
			Network Factory Reset			
		Serial Port Baud Rate	9600		19200	
14400						
19200						
38400						
57600						
115200						

USING THE PROJECTOR

Main Menu	Sub Menu	Sub Menu 2	Sub Menu 3	Sub Menu 4	Values	
SETUP	Communications	Serial Port Path	RS232		RS232	
			HDBaseT			
		Projector ID	0 - 99		0	
		IR Control	Front	Off		On
				On		
			Top	Off		On
				On		
			HDBaseT	Off		Off
				On		
		OPTION	Auto Source	Off		
On						
High Altitude	Off				Off	
	On					
Test Pattern	Off				Off	
	Grid					
	Red					
	Green					
	Blue					
	Yellow					
	Magenta					
	Cyan					
	White					
	Black					
Grid Pattern	Off				Off	
	Red					
	Green					
	White					
Background Color	Logo				Logo	
	Blue					
	Black					
	White					
Hot-Key settings	Blank Screen				Blank Screen	
	Aspect Ratio					
	Freeze Screen					
	Overscan					
Power Settings	Standby Power Mode		0.5W mode			0.5W mode
			Communication mode			
	Direct Power On		Off			Off
			On			
	Auto Power Off		No			20 Mins
			5 Mins			
		10 Mins				
		15 Mins				
		20 Mins				
		25 Mins				
30 Mins						

USING THE PROJECTOR

Main Menu	Sub Menu	Sub Menu 2	Sub Menu 3	Sub Menu 4	Values	
OPTION	Power Settings	Sleep Timer	No		No	
			2 Hours			
			4 Hours			
			6 Hours			
	Light Source Settings	Light Source Mode		Constant Power		Constant Power
				Constant Luminance		
				Eco Mode		
		Constant Power Settings	0 - 99		99	
	Light Sensor			Total Projector Hours		
				Default		
				Auto		
	Information			Manual		
				Model Name		
				Serial Number		
				Native Resolution		
				Firmware		
				Main Source		
				- Resolution		
				- Signal Format		
				- Pixel Clock		
				- Horz Refresh		
				- Vert Refresh		
				Sub Source		
				- Resolution		
				- Signal Format		
				- Pixel Clock		
				- Horz Refresh		
				- Vert Refresh		
				Light Source Mode		
				Total Projector Hours		
				Standby Power Mode		
	IP Address					
	DHCP					
	Factory Reset	Yes/No (Dialog box)				
	Service			Factory Reset	Yes/No (Dialog box)	
				Filter Wheel Index		
				Phosphor Wheel Index		
				Error Log		
				Mode Adjustment		
				Reset Projector Hours		
Light Sensor Calibration						
ADC Calibration						
LD Hours						
UST Lens Install						

USING THE PROJECTOR

DISPLAY menu

DISPLAY	
DISPLAY	Display Mode Presentation
OUTPUT	Brightness 50
	Contrast 50
	Sharpness 8
SETUP	Color 50
	Tint 50
	Phase 50
OPTION	Frequency 50
	Horz Position 50
	Vert Position 50

DISPLAY (1/2)

DISPLAY	
DISPLAY	3D ▲
OUTPUT	Color Matching
	Advanced
SETUP	
OPTION	

DISPLAY (2/2)

Display Mode

There are many factory presets optimized for various types of images.

- **Presentation:** This mode is suitable for showing PowerPoint presentations when the projector is connected to the PC.
- **Movie:** This mode is suitable for watching movie.
- **Bright:** Maximum brightness from PC input.
- **REC709:** This color mode matches the REC.709 color standard as closely as possible.
- **DICOM SIM:** This mode offer medical educators and training professionals the ability to display medical images.
- **2D High Speed:** Display the status of 2D High Speed mode (This mode should not be used for medical diagnosis).
Note: *If the resolution of the input source is 800x600 at 120Hz, 1024x768 at 120Hz, or 1280x720 120Hz, then the display mode will automatically switch to 2D High Speed.*
- **3D:** Recommended setting for 3D mode enabled. Any further adjustments by the user in 3D will be saved in this mode for further use.
- **Blending:** When using multiple projectors, this mode can eliminate the visible banding and create a single bright, high resolution image across the screen.

USING THE PROJECTOR

- **User:** Memorize user's settings. Any adjustment in this mode will be automatically saved.
- **Save to User:** Save the current display mode settings in user profile.

Brightness

Adjust the brightness of the image.

Contrast

The contrast controls the degree of difference between the lightest and darkest parts of the picture.

Sharpness

Adjust the sharpness of the image.

Color

Adjust a video image from black and white to fully saturated color.

Tint

Adjust the color balance of red and green.

Phase

Synchronize the signal timing of the display with the graphic card. If the image appears to be unstable or flickers, use this function to correct it.

Frequency

Change the display data frequency to match the frequency of your computer's graphic card. Use this function only if the image appears flickering vertical lines.

Horz Position

Move the image right or left within the area of available pixels.

Vert Position

Move the image up or down within the area of available pixels.

3D

Configure the 3D display settings. Refer to "3D menu" on page 32.

Color Matching

Configure the color management settings. Refer to "Color Matching menu" on page 33.

Advanced

Configure the advanced image settings. Refer to "Advanced menu" on page 34.

USING THE PROJECTOR

3D menu

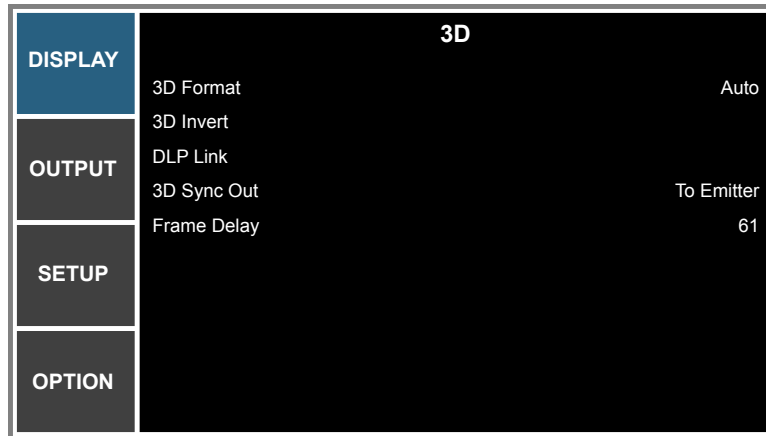

3D Format

Set 3D format. Supports Mandatory 3D formats and frame sequential 3D@120Hz.

- **Auto:** When a 3D identification signal is detected, the 3D format is selected automatically.
- **Frame Packing:** Display 3D signal in “Frame Packing” format.
- **Side by Side:** Display 3D signal in “Side by Side” format.
- **Top and Bottom:** Display 3D signal in “Top and Bottom” format.
- **Frame Sequential:** Display 3D signal in “Frame Sequential” format.
- **Off:** Disable the function.

3D Invert

Choose to enable or disable inverting 3D sync signal for the application of using single projector.

- **On:** Invert the left and right frame contents.
- **Off:** Display the default frame contents.

DLP Link

Select 3D Sync source.

- **On:** 3D Sync type is DLP Link.
- **Off:** 3D Sync source is from the **3D Sync OUT** connector.

3D Sync Out

Transmit a 3D sync signal by the 3D sync output corrector to the emitter or to the next projector for 3D blending purposes.

Frame Delay

Set the frame delay to correct asynchronous displaying image under 3D blending.

USING THE PROJECTOR

Color Matching menu

Color Matching	
DISPLAY	HSG Enable Color Enhancement 1
	Auto Test Pattern On
OUTPUT	Red H. 127
	Red S. 127
	Red G. 127
SETUP	Green H. 127
	Green S. 127
	Green G. 127
OPTION	Blue H. 127
	Blue S. 127

HSG Enable

The HSG adjustment function has 4 Color Enhancement settings: Off, Color Enhancement 1, Color Enhancement 2, and User.

Only the **User** option can be customized for the desired color. Other settings have their own fixed color settings.

Auto Test Pattern

Set to “On” to display a test pattern for the target color or set to “Off” to disable the auto test pattern.

Red H. / Green H. / Blue H. / Cyan H. / Magenta H. / Yellow H.

Adjust the hue of the red, green, blue, cyan, magenta, or yellow channel of the image.

Red S. / Green S. / Blue S. / Cyan S. / Magenta S. / Yellow S.

Adjust the saturation of the red, green, blue, cyan, magenta, or yellow channel of the image.

Red G. / Green G. / Blue G. / Cyan G. / Magenta G. / Yellow G.

Adjust the gain of the red, green, blue, cyan, magenta, or yellow channel of the image.

White R Gain / White G Gain / White B Gain

Adjust the white balance of the red, green, or blue channel of the image.

Reset to Default

Reset the hue, saturation, gain, and white balance adjustments to the factory defaults.

USING THE PROJECTOR

Advanced menu

Advanced	
DISPLAY	White Peaking 100 Gamma Graphic
OUTPUT	Color Temperature Cool Color Space Auto RGB Gain/Bias
SETUP	Color Wheel Speed 2X Film Mode On Extreme Black Off
OPTION	Dynamic Black Off

White Peaking

(Video source only) Increase the brightness of whites that are near 100%.

Gamma

This allows you to set up gamma curve type. After the initial setup and fine tuning is completed, utilize the Gamma adjustment steps to optimize your image output.

- **Video:** for video or TV source.
- **Film:** for home theater.
- **Blackboard:** for emphasizing brightness.
- **Graphic:** for computer source or RGB source.
- **DICOM:** independent gamma setting of the display mode for **DICOM SIM**.
- **Gamma 2.2:** independent gamma setting of the display mode for **Blending**.

Color Temperature

Select a color temperature from Warm, Medium, Cool, or Cold.

Color Space

Select an appropriate color matrix type from RGB, REC709, REC601, RGB Video, or Auto.

RGB Gain/Bias

Configure the brightness (gain) and contrast (offset) of an image.

- **Red Gain/Green Gain/Blue Gain/Red Offset/Green Offset/Blue Offset:** Adjust the gain of the red, green, or blue channel of the image. Adjust the offset of the red, green, or blue channel of the image. It will affect the black and white.
- **Reset RGB Gain/Offset:** Reset the gain and offset adjustments to the factory defaults.

Color Wheel Speed

Adjust the wheel speed.

- **2X:** provides quieter sound and longer life.
- **3X:** provides better color performance.

Film Mode

Control film mode detection and determine whether the original source of the input video was film or video.

Note: This function is available for interlaced video signals.

USING THE PROJECTOR

Extreme Black

Contrast can be increased when a blank (black) image is displayed. Select “On” and the projector will automatically improve contrast or select “Off” to disable this function.

Dynamic Black

Contrast can be dynamically increased when viewing gray or dark content. Select “On” to let the projector automatically improve contrast or select “Off” to disable this function.

Only Extreme Black or Dynamic Black can be enabled simultaneously.

Note: *Extreme Black and Dynamic Black are disabled when Constant Luminance is enabled.*

OUTPUT menu

OUTPUT	
DISPLAY	Aspect Ratio Auto
	Overscan Off
OUTPUT	H Digital Zoom 99
	V Digital Zoom 99
	H Digital Shift 50
	V Digital Shift 50
SETUP	Image Warping
	PIP/PBP Settings
OPTION	

Aspect Ratio

Choose your desired aspect ratio.

- **Auto:** Automatically selects the appropriate display format.
- **4:3:** This format is for 4:3 input sources.
- **16:9:** This format is for 16:9 input sources.
- **16:10:** This format is for 16:10 aspect input sources, like HDTV and DVD enhanced for Wide screen TV.
- **Native:** This format displays the original image without any scaling.

Scaling table:

	480i/p	576i/p	1080i/p	720p	PC
Auto	Fixed ratio of source and scalar to match the height or weight of DMD resolution.				
4x3	Scale to 1600x1200.				
16x9	Scale to 1920x1080 (1600x1200 will be 1600x900).				
16x10	Scale to 1920x1200				
Native mode	1:1 mapping centered				

Overscan

Remove noise around the image.

H Digital Zoom

Change the size of projector’s display area horizontally. If the display area has been resized by this setting, it can be moved by changing the H Digital Shift setting.

USING THE PROJECTOR

V Digital Zoom

Change the size of projector's display area vertically. If the display area has been resized by this setting, it can be moved by changing the V Digital Shift setting.

H Digital Shift

Shift the display area horizontally if its size has been changed by the H Digital Zoom setting.

V Digital Shift

Shift the display area vertically if its size has been changed by the V Digital Zoom setting.

Image Warping

Configure the image warping settings. Refer to "Image Warping menu" on page 36.

PIP/PBP Settings

Configure the PIP/PBP settings. Refer to "PIP/PBP Settings menu" on page 38.

Image Warping menu

Image Warping	
DISPLAY	PC Mode Off
OUTPUT	H Keystone 20
	V Keystone 20
	H Pincushion 50
	V Pincushion 50
SETUP	4-Corner
	Reset to Default
OPTION	

PC Mode

Enable PC software to control advanced geometry using multi-point grid adjustment.

H Keystone

Adjust image distortion horizontally and make a squarer image. Horizontal keystone is used to correct a keystone image shape in which the left and right borders of the image are unequal in length. This is intended for use with horizontally on-axis applications.



USING THE PROJECTOR

V Keystone

Adjust image distortion vertically and make a squarer image. Vertical keystone is used to correct a keystone image shape in which the top and bottom are slanted to one of the sides. This is intended when for use with vertically on-axis applications.

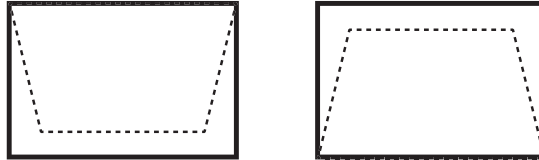

H Pincushion

Adjust the pincushion horizontally and make a more square image.

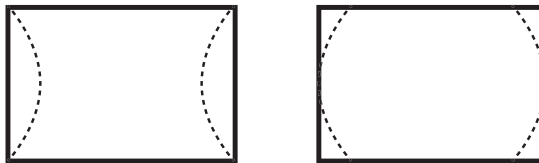

V Pincushion

Adjust the pincushion vertically and make a more square image.

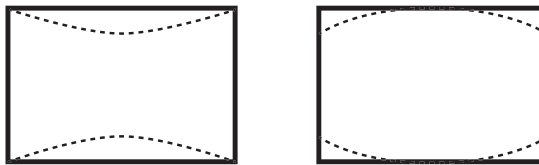

4-Corner

Allow the image to be squeezed to fit an area defined by moving each of the four corners' x and y position.

- **Top left corner adjust:** Top left corner can move in to squeeze the image by maximum 120 pixels horizontally and 80 pixels vertically.
- **Top right corner adjust:** Top right corner can move in to squeeze the image by maximum 120 pixels horizontally and 80 pixels vertically.
- **Bottom left corner adjust:** Bottom left corner can move in to squeeze the image by maximum 120 pixels horizontally and 80 pixels vertically.
- **Bottom right corner adjust:** Bottom right corner can move in to squeeze the image by maximum 120 pixels horizontally and 80 pixels vertically.

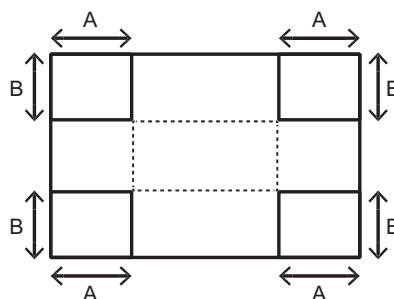

Reset to Default

Reset all image warp setting back to default.

USING THE PROJECTOR

PIP/PBP Settings menu

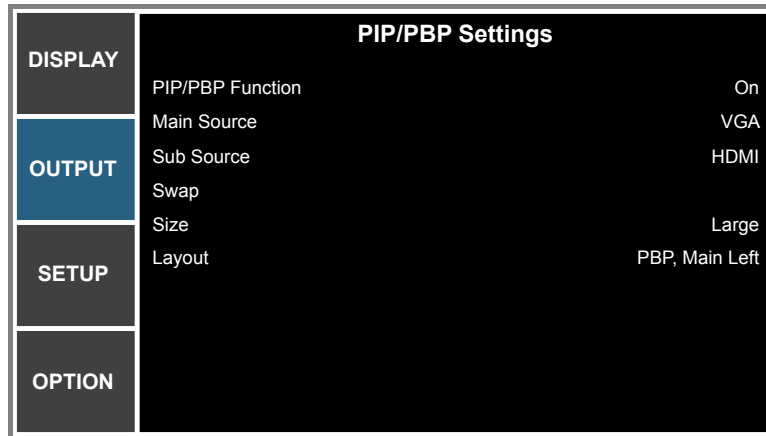

PIP/PBP Function

Toggle between displaying two sources at once (Main and PIP/PBP images) or one source only.

Main Source

From the list of active inputs, select one to be used as the main image.

Sub Source

From the list of active inputs, select one to be used as the sub image.

Swap

Swap the sources of main window and PIP/PBP window.

Size

Select the PIP/PBP size.

Layout

Set the location of the PIP/PBP image on the screen.

PIP/PBP Matrix

PIP/PBP compatibility table as described below:













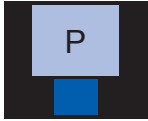





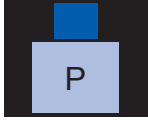

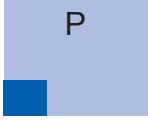

PIP/PBP Matrix	HDMI	Network Display	HDBaseT	3G-SDI	VGA	DVI-D
HDMI	—	—	—	V	V	V
Network Display	—	—	—	V	V	V
HDBaseT	—	—	—	V	V	V
3G-SDI	V	V	V	—	—	—
VGA	V	V	V	—	—	—
DVI-D	V	V	V	—	—	—

Note:

1. Flashing lines may occur if the bandwidth of both inputs are too high, please try to reduce the resolution.
2. Frame tearing may occur due to a difference in frame rate between the Main and the Sub picture, please try to match the frame rate for each input.

USING THE PROJECTOR

PIP/PBP layout and size table as described below:

PIP/PBP Layout	PIP/PBP Size		
	Small	Medium	Large
PBP, Main Left			
PBP, Main Top			
PBP, Main Right			
PBP, Main Bottom			
PIP-Bottom Right			
PIP-Bottom Left			
PIP-Top Left			
PIP-Top Right			

USING THE PROJECTOR

SETUP menu

SETUP	
DISPLAY	Language English
	Ceiling Mount Auto
OUTPUT	Rear Projection Off
	Lens Settings
	Menu Settings
SETUP	Keypad LED Settings On
	Security
OPTION	Communications

Language

Choose the multilingual OSD menu.

Ceiling Mount

Turn the image upside down for ceiling-mounted projection.

Rear Projection

Reverse the image so you can project from behind a translucent screen.

Lens Settings

Configure the lens function settings. Refer to “Lens Settings menu” on page 40.

Menu Settings

Configure the menu preferences settings. Refer to “Menu Settings menu” on page 41.

Keypad LED Settings

Turn the backlight of keypad on or off.

Security

Configure the security settings. Refer to “Security menu” on page 42.

Communications

Configure the communications settings. Refer to “Communications menu” on page 42.

Lens Settings menu

Lens Settings	
DISPLAY	Focus
	Zoom
OUTPUT	Lens Shift
	Lens Calibration
	Lens Memory
SETUP	Lens Lock No
OPTION	

USING THE PROJECTOR

Focus

Adjust focus function on the projected image.

Zoom

Adjust zoom function on the projected image.

Lens Shift

Shift the projected image.

Lens Calibration

Perform calibration and return lens to the center position.

Lens Memory

Save the current lens position after doing lens shift. Apply lens position to the chosen set of lens memory. The lens memory can be set and saved up to maximum five.

Lens Lock

Select this function to prevent all lens motors from moving.

- **No:** Lens shift can be used by user.
- **Yes:** Lens shift will be locked.

Menu Settings menu

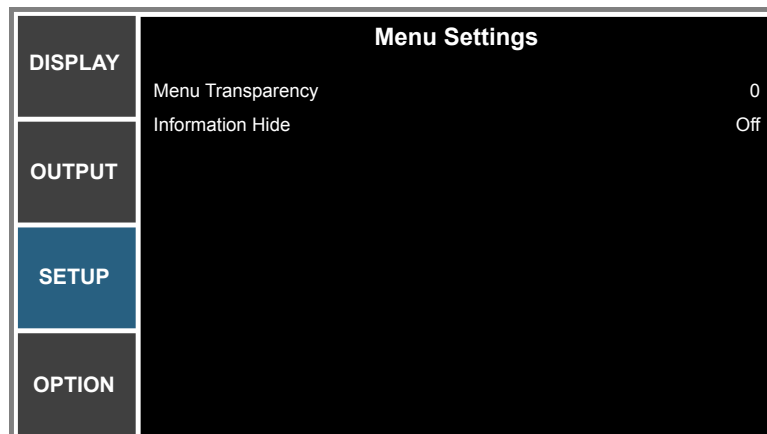

Menu Transparency

Change OSD menu background to be transparent.

Information Hide

Enable this function to hide the information message.

USING THE PROJECTOR

Security menu



Password

The Security feature allows you to password protect your projector. Once you enable the Security feature, you must enter the password before you can project an image.

Note: The password default value is "12345".

Change Password

Change the password.

Communications menu

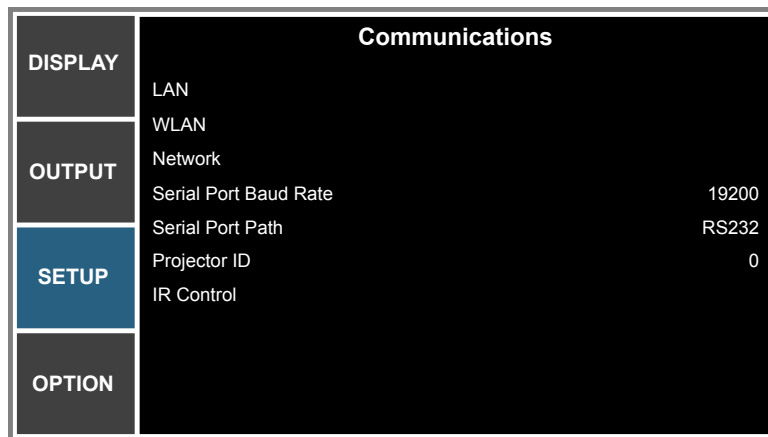

LAN

Configure the local area network (LAN) settings.

- **DHCP:** Turn the DHCP On/Off.
- **IP Address:** Select an IP address.
- **Subnet Mask:** Select subnet mask number.
- **Gateway:** Select the default gateway of the network connected to the projector.
- **MAC Address:** Display the network MAC Address value.
- **Apply:** Apply Network settings.

USING THE PROJECTOR

WLAN

Configure the wireless local area network (WLAN) settings.

- **Enable:** Enable/Disable WLAN.
- **Start IP:** Start of IP Address.
- **End IP:** End of IP Address.
- **Subnet Mask:** Assign Network Subnet Mask.
- **Gateway:** Assign Network Default Gateway.
- **MAC Address:** Display network MAC Address value.
- **SSID:** Assign Network Service Set Identifier.

Network

Configure the general network settings.

- **Projector Name:** Display the projector hostname for Network.
- **Restart Network:** Restart the network.
- **Network Factory Reset:** Perform factory reset on the network settings. The Projector Name, LAN IP, WLAN IP, and SNMP settings will be reset

Serial Port Baud Rate

Baud rate is the time of the data transmission. Select the serial port baud rate and make sure the OSD's setting is same as the device's setting.

Serial Port Path

Select the serial port path from either RS232 or HDBaseT.

Projector ID

Set the projector ID. ID definition can be set up by menu (range 0-99), and allow user control an individual projector by using RS232 command.

IR Control

Set the IR settings on or off. User is able to control the communication between projector and remote control/HD BaseT depending on the IR settings.

- **Front:** Enable or disable the Front IR Sensor.
- **Top:** Enable or disable the Top IR Sensor.
- **HDBaseT:** Enable or disable the remote control for HDBaseT.

USING THE PROJECTOR

How to use web browser to control your projector

1. Turn “On” the DHCP option on projector to allow a DHCP server to automatically assign an IP address.
2. Open the web browser in your PC and type in the projector’s IP address (“SETUP: Communications > LAN > IP Address”).

Note: The steps in this section is based on Windows 7 operating system.

Making a direct connection from your computer to the projector* (For Windows 7 or higher)

1. Turn “Off” the DHCP option on the projector.
2. Configure the IP address, Subnet Mask, and Gateway on projector. Refer to “Communications menu” on page 42.
3. Open **Network and Sharing Center** page on your PC, and assign the identical network parameters to your PC as set on projector. Click “OK” to save the parameters.

Note: The last group (ex: 100) of the IP address should be different from the projector. Make sure the network parameters (i.e. other groups of the IP address and the Subnet mask) are similar to those shown in the OSD menu.

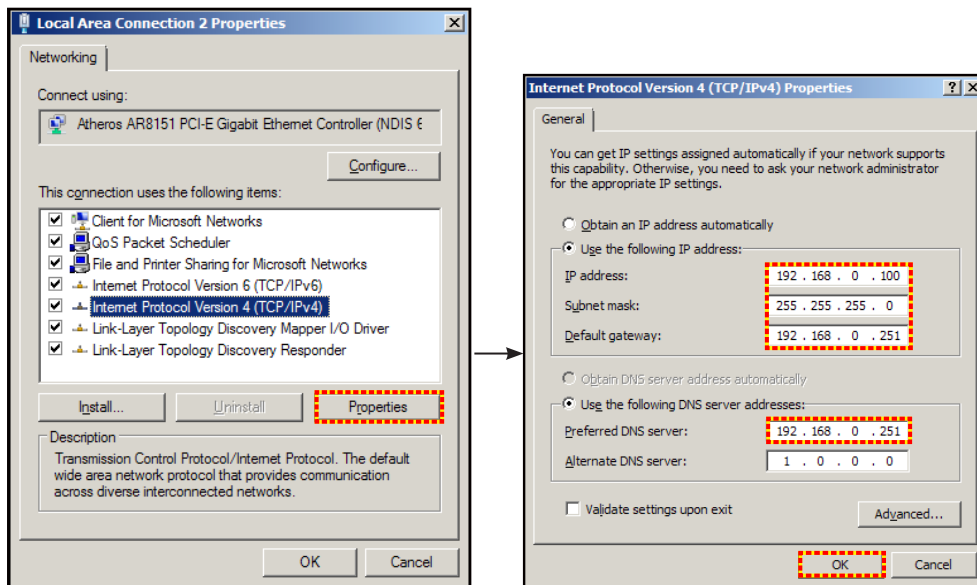

4. Open the web browser on your computer and type the projector IP address into the URL field, then press “Enter”.

USING THE PROJECTOR

Setup network control settings menu

LAN_RJ45 function

For simplicity and ease of operation, the projector provides diverse networking and remote management features. The LAN / RJ45 function of the projector through a network, such as remotely manage: Power On / Off, Brightness and Contrast settings. Also you can view the projector status information, such as: Video- Source, etc.

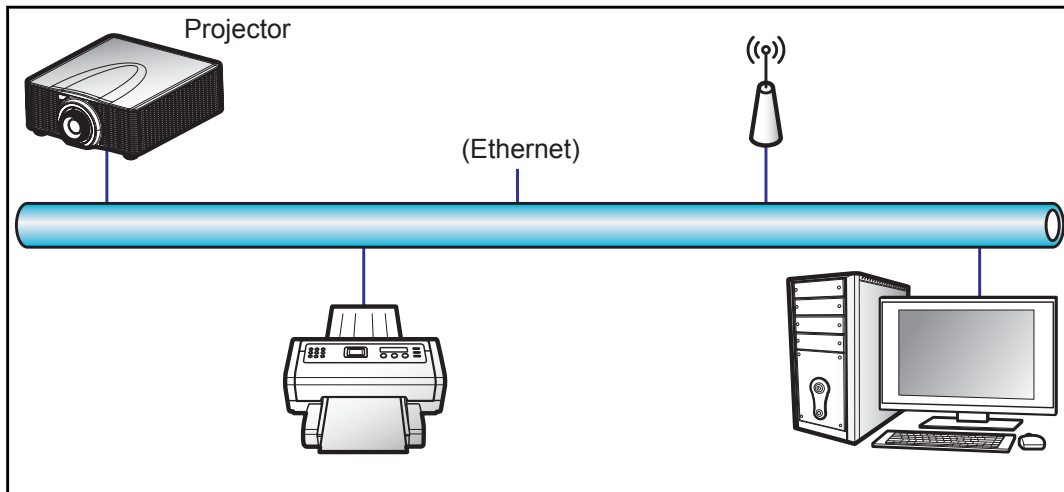

Wired LAN terminal functionalities

This projector can be controlled by using a PC (laptop) or other external device via LAN connector and compatible with Crestron / Extron / AMX (Device Discovery) / PJLink.

- Crestron is a registered trademark of Crestron Electronics, Inc. of the United States.
- Extron is a registered trademark of Extron Electronics, Inc. of the United States.
- AMX is a registered trademark of AMX LLC of the United States.
- PJLink applied for trademark and logo registration in Japan, the United States of America, and other countries by JBMIA.

The projector is supported by the specified commands of the Crestron Electronics controller and related software, for example RoomView®.

<http://www.crestron.com/>

This projector is compliant to support Extron device(s) for reference.

<http://www.extron.com/>

This projector is supported by AMX (Device Discovery).

<http://www.amx.com/>

This projector supports all commands of PJLink Class1 (Version 1.00).

<http://pjlink.jbmia.or.jp/english/>

For more detailed information about the various types of external devices which can be connected to the LAN / RJ45 port and remote control the projector, as well as the supported commands for these external devices, please contact the Support-Service directly.

USING THE PROJECTOR

LAN RJ45 (For Windows XP)

1. Connect an RJ45 cable to LAN connector on the projector and the PC (laptop).

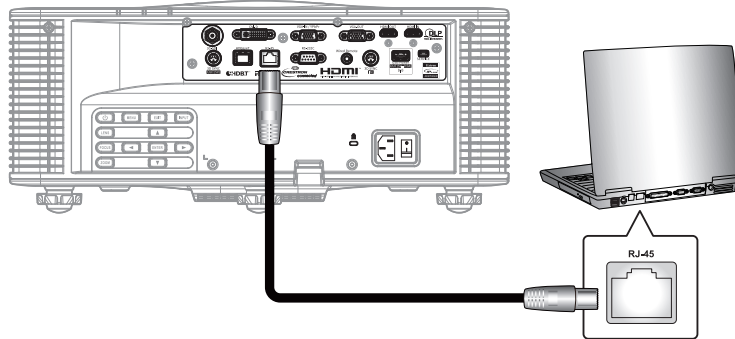

2. On the PC (Laptop), select **Start > Control Panel > Network Connections**.

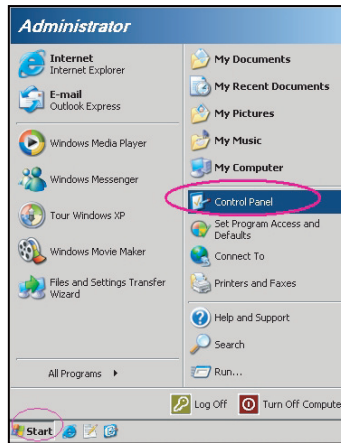

3. Right-click on the **Local Area Connection**, and select **Property**.

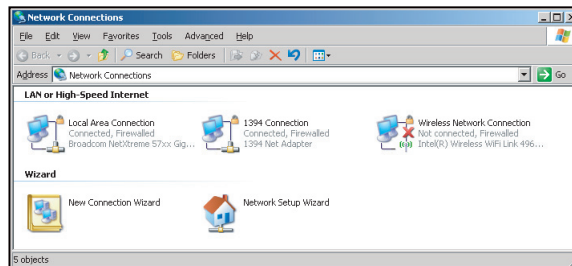

4. In the **Properties** window, select the **General tab**, and select **Internet Protocol (TCP / IP)**.

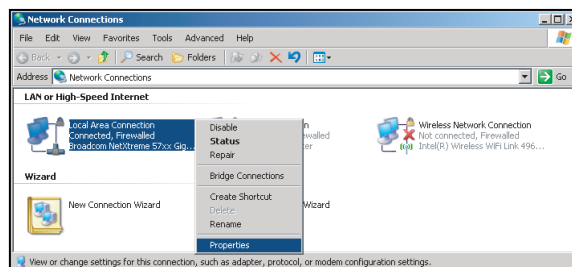

USING THE PROJECTOR

5. Click “Properties”.

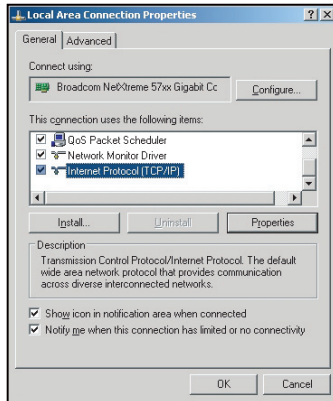

6. Type in the IP address and Subnet mask, then press “OK”.

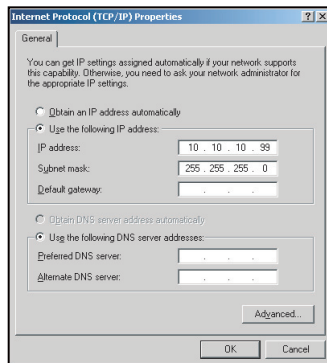

7. Press the “Menu” button on the projector.
8. Select **SETUP > Communications > LAN**.
9. Enter the following connection parameters:
 - DHCP: Off
 - IP Address: 10.10.10.10
 - Subnet Mask: 255.255.255.0
 - Default Gateway: 0.0.0.0
10. Press “Enter” to confirm settings.
11. Open a web browser, for example Microsoft Internet Explorer with Adobe Flash Player 9.0 or higher installed.
12. In the Address bar, input the projector’s IP address: 10.10.10.10.

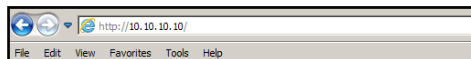

13. Press “Enter”.
The projector is setup for remote management. The LAN / RJ45 function displays as follows:

USING THE PROJECTOR

Main page

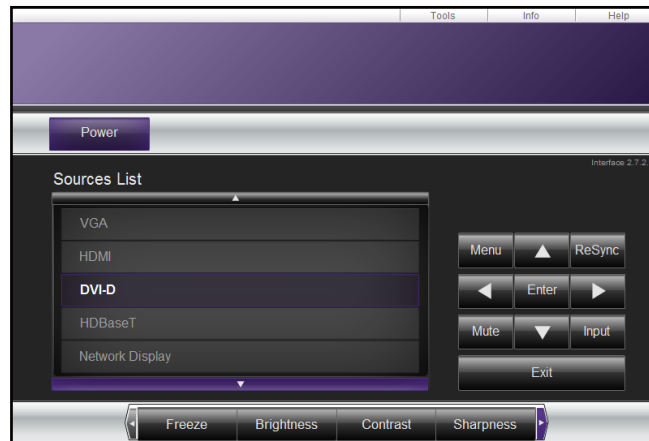

Information page

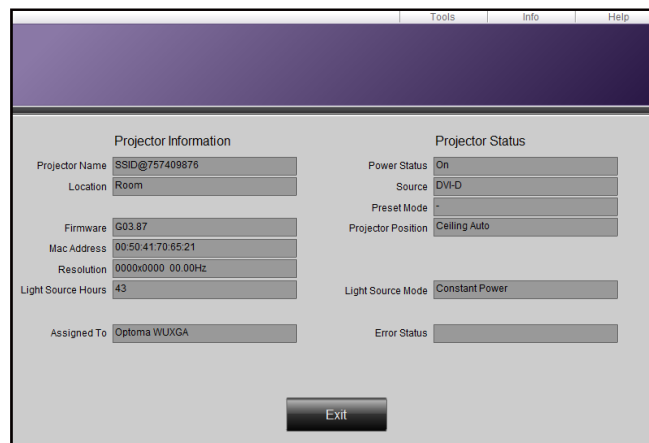

Tool page

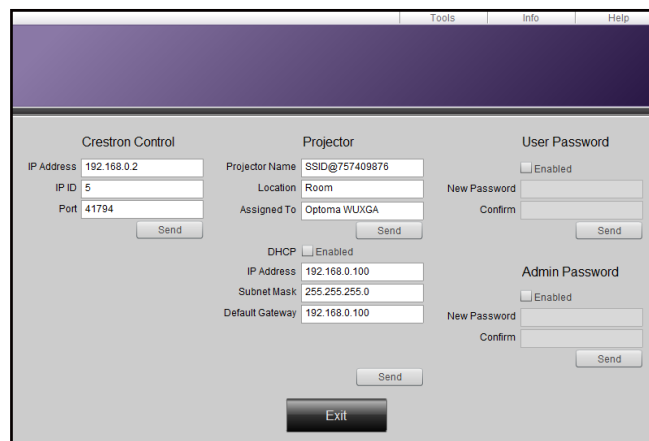

Contact IT helpdesk



USING THE PROJECTOR

RS232 by Telnet Function

There is alternative RS232 command control way, in projector so called “RS232 by TELNET” for LAN / RJ45 interface.

Quick Start-Guide for “RS232 by Telnet”

- Check and get the IP address on OSD of the projector.
- Make sure that the PC / laptop can access the web-page of the projector.
- Make sure that “Windows Firewall” setting is set disabled in case of “TELNET” function filtering out by PC / laptop.

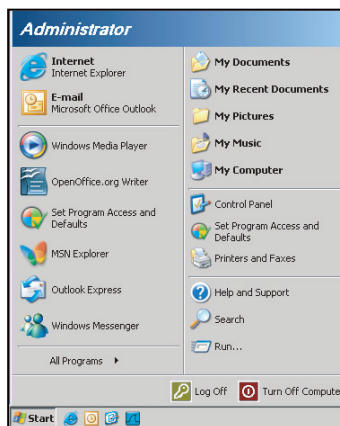

1. Select **Start > All Programs > Accessories > Command Prompt**.

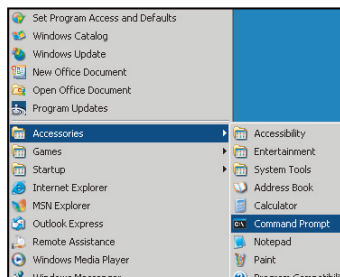

2. Input the command format as follows:
 - telnet ttt.xxx.yyy.zzz 3023 (“Enter” key pressed)
 - (ttt.xxx.yyy.zzz: IP-Address of the projector)
3. If Telnet-Connection ready, and user can have RS232 command input, then “Enter” key pressed, the RS232 command will be workable.

Specification for “RS232 by TELNET”:

1. Telnet: TCP.
2. Telnet port: 3023 (for more detail, kindly please get contact with the service agent or team).
3. Telnet utility: Windows “TELNET.exe” (console mode).
4. Disconnection for RS232-by-Telnet control normally: Close
5. Windows Telnet utility directly after TELNET connection ready.
 - Limitation 1 for Telnet-Control: there is less than 50 bytes for successive network payload for Telnet-Control application.
 - Limitation 2 for Telnet-Control: there is less than 26 bytes for one complete RS232 command for Telnet-Control.
 - Limitation 3 for Telnet-Control: Minimum delay for next RS232 command must be more than 200 (ms).

USING THE PROJECTOR

OPTION menu

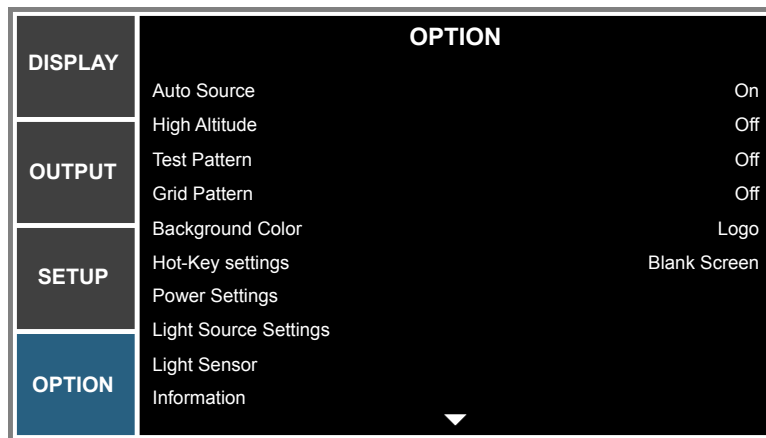

OPTION (1/2)

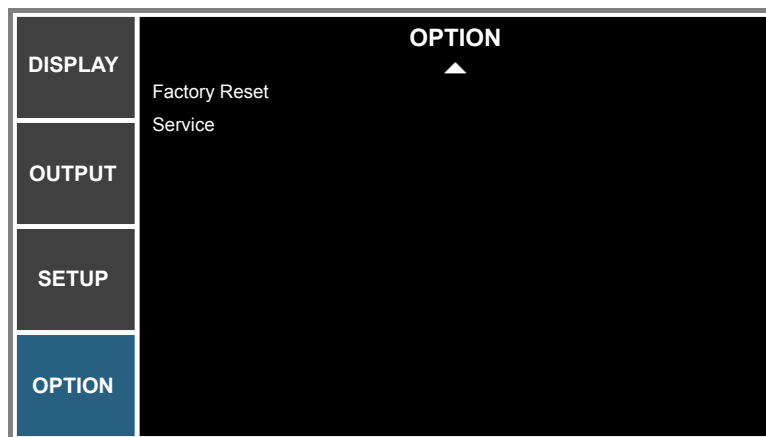

OPTION (2/2)

Auto Source

Use this option to enable/disable input sources.

- **On:** The projector will search for other signals if the current input signal is lost.
- **Off:** The projector will only search current input connection.

High Altitude

When “On” is selected, the fans will increase speed. This feature is useful in high altitude locations where the air is thin.

Test Pattern

Display a test pattern or select “Off” to turn off a test pattern.

Grid Pattern

Display a “Red”, “Green”, or “White” pattern during projector offset adjustments.

Background Color

Use this feature to display a “Logo”, “Blue”, “Black”, or “White” screen when no signal is available.

Hot-Key settings

Assign a different function to the hot-key on the remote control by highlighting the function in the list and pressing “Enter”. Choose a function that does not already have a dedicated button, and assign the hot-key to that function, allowing you to quickly and easily use the chosen function.

USING THE PROJECTOR

Power Settings

Configure the power settings. Refer to page 51.

Light Source Settings

Configure the light source settings. Refer to “Light Source Settings menu” on page 52.

Light Sensor

Set the light sensor calibration option to “Default”, “Auto”, or “Manual”.

- **Default:** Light sensor is calibrated at the cooling stage.
- **Auto:** Light sensor is calibrated every 168 hours.
- **Manual:** Calibrate the light sensor manually.

Information

Display the projector information for source, resolution, and software version on the screen.

Factory Reset

Restore all settings to their default value. It will not reset network.

Power Settings menu

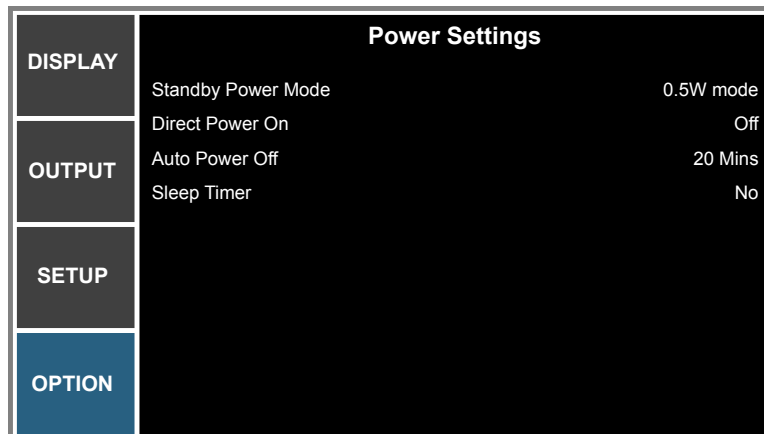

Standby Power Mode

Set the standby power mode setting.

- **0.5W mode:** The projector is in standby mode when connected to AC power. (<0.5W)
- **Communication mode:** The projector can be controlled via the LAN terminal during power standby.

Direct Power On

Choose “On” to activate Direct Power mode. The projector will automatically power on when AC power is supplied, without pressing “**1**” on the remote control or press “**⏻**” on the projector keypad.

Auto Power Off

Set the countdown timer interval. The countdown timer will start, when there is no signal being sent to the projector. The projector will automatically power off when the countdown has finished (in minutes).

Sleep Timer

Sets the countdown timer interval. The countdown timer will start, with or without a signal being sent to the projector. The projector will automatically power off when the countdown has finished.

Note: The value of sleep timer will be reset to zero after the projector is powered off.

USING THE PROJECTOR

Light Source Settings menu

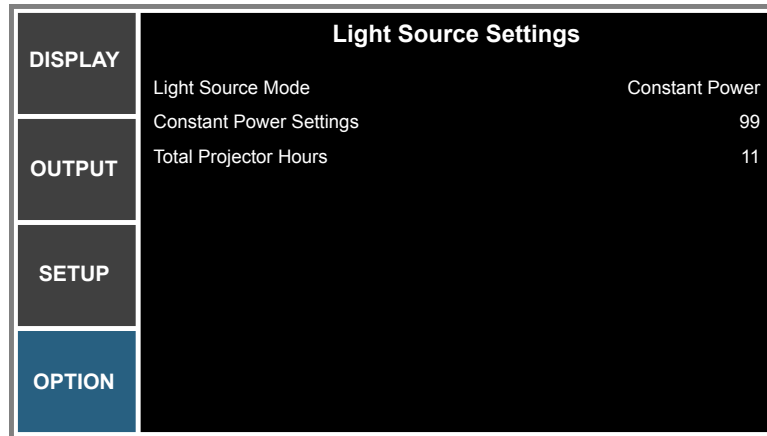

Light Source Mode

Set the light source mode setting.

- **Constant Power:** Set the brightness of the projector by changing the value in Constant Power Settings.
- **Constant Luminance:** Set the value in Constant Power Settings and change the Light Source Mode to Constant Luminance to maintain the constant brightness.
Note: *To enable Constant Luminance, go to Service Menu to do light sensor calibration. After Constant Luminance is enabled, Dynamic Black and Extreme Black are automatically disabled.*
- **Eco mode:** The factory default brightness is 50%.

Constant Power Settings

Set the value of the laser diode power.

Note: *This can be used for Constant Luminance. Set the value of light source power in Constant Power and change Light Source Mode to Constant Luminance to lock at current brightness.*

Total Projector Hours

Display the projection time.

ADDITIONAL INFORMATION

Compatible resolutions

Timing Table

Signal Type	Resolution	Frame rate (Hz)	QD881	VGA	HDMI	DVI	HDBaseT	3G-SDI
PC	640x480	60	DMT0660	V	V	V	V	—
	640x480	72	DMT0672	V	V	V	V	—
	640x480	75	DMT0675	V	V	V	V	—
	640x480	85	DMT0685	V	V	V	V	—
	640x480	66.6	APP0667	—	V	V	V	—
	720x400	70	IBM0770H	V	V	V	V	—
	800x600	60	DMT0860	V	V	V	V	—
	800x600	72	DMT0872	V	V	V	V	—
	800x600	75	DMT0875	V	V	V	V	—
	800x600	85	DMT0885	V	V	V	V	—
	800x600	120	CVR0812	V	V	V	V	—
	832x624	75	8362A75	V	V	V	V	—
	848x480	50	CVT0850H	—	V	V	V	—
	848x480	60	CVT0860H	—	V	V	V	—
	848x480	75	CVT0875H	—	V	V	V	—
	848x480	85	CVT0885H	—	V	V	V	—
	1024x768	60	DMT1060	V	V	V	V	—
	1024x768	75	DMT1075	V	V	V	V	—
	1024x768	85	DMT1085	V	V	V	V	—
	1024x768	120	CVR1012	V	V	V	V	—
	1152x720	50	CVT1150D	—	V	V	V	—
	1152x720	60	CVT1160D	—	V	V	V	—
	1152x720	75	CVT1175D	—	V	V	V	—
	1152x720	85	CVT1185D	—	V	V	V	—
	1152x864	60	CVT1160	V	V	V	V	—
	1152x864	70	DMT1170	V	V	V	V	—
	1152x864	75	DMT1175	V	V	V	V	—
	1152x864	85	DMT1185	V	V	V	V	—
	1152x870	75	APP1175	—	V	V	V	—
	1280x720	50	CVT1250H	—	V	V	V	—
	1280x720	60	CVT1260H	V	V	V	V	—
	1280x720	75	CVT1275H	V	V	V	V	—
	1280x720	85	CVT1285H	V	V	V	V	—
	1280x720	120		V	V	V	V	—
	1280x768	60	CVT1260E	V	V	V	V	—
	1280x768	75	CVT1275E	V	V	V	V	—
	1280x768	85	CVT1285E	V	V	V	V	—
	1280x800	50	CVT1250_	V	V	V	V	—
	1280x800	60	DMT1260D	V	V	V	V	—
	1280x800	75	CVT1275_	V	V	V	V	—
1280x800	85	CVT1285_	V	V	V	V	—	
1280x960	50	CVT1250	—	V	V	V	—	
1280x960	60	CVT1260	V	V	V	V	—	
1280x960	75	CVT1275	V	V	V	V	—	
1280x960	85	CVT1285	V	V	V	V	—	

ADDITIONAL INFORMATION

Signal Type	Resolution	Frame rate (Hz)	QD881	VGA	HDMI	DVI	HDBaseT	3G-SDI
PC	1280x1024	50	CVT1250G	—	V	V	V	—
	1280x1024	60	DMT1260G	V	V	V	V	—
	1280x1024	75	DMT1275G	V	V	V	V	—
	1280x1024	85	DMT1285G	V	V	V	V	—
	1360x768	50	CVT1350H	—	V	V	V	—
	1360x768	60	DMT1360H	—	V	V	V	—
	1360x768	75	CVT1375H	—	V	V	V	—
	1360x768	85	CVT1385H	—	V	V	V	—
	1366x768	60	DMR1360H	V	V	V	V	—
	1400x1050	50	CVT1450	—	V	V	V	—
	1400x1050	60	CVT1460	—	V	V	V	—
	1400x1050	75	CVT1475	V	V	V	V	—
	1440x900	60	CVT1460D	V	V	V	V	—
	1440x900	75	CVT1475D	—	V	V	V	—
	1600x900	60	DMR1660H	—	V	V	V	—
	1600x1200	60	DMT1660	V	V	V	V	—
	1680x1050	60	CVT1660D	V	V	V	V	—
	1920x1080	50	CVT1950H	—	V	V	V	—
	1920x1080	60	CVR1960H	V	V	V	V	—
	1920x1200RB	60	CVR1960D	V	V	V	V	—
1920x1200RB	50	CVT1950D	V	V	V	V	—	
NTSC	NTSC (M, 4.43)	60		—	—	—	—	—
PAL	PAL (B,G,H,I)	50		—	—	—	—	—
	PAL (N)	50		—	—	—	—	—
	PAL (M)	60		—	—	—	—	—
SECAM	SECAM (M)	50		—	—	—	—	—
SDTV	480i	60		V	V	V	V	—
	576i	50		V	V	V	V	—
EDTV	480p	60		V	V	V	V	—
	576p	50		V	V	V	V	—
HDTV	1080i	25		V	V	V	V	—
	1080i	29		V	V	V	V	—
	1080i	30		V	V	V	V	—
	720p	50		V	V	V	V	—
	720p	59		V	V	V	V	—
	720p	60		V	V	V	V	—
	1080p	23		V	V	V	V	—
	1080p	24		V	V	V	V	—
	1080p	25		V	V	V	V	—
HDTV	1080p	29		V	V	V	V	—
	1080p	30		V	V	V	V	—
	1080p	50		V	V	V	V	—
	1080p	59		V	V	V	V	—
	1080p	60		V	V	V	V	—

ADDITIONAL INFORMATION

Signal Type	Resolution	Frame rate (Hz)	QD881	VGA	HDMI	DVI	HDBaseT	3G-SDI
Mandatory 3D	Frame Packing 1080p	24		—	V	—	V	—
	Frame Packing 720p	50		—	V	—	V	—
	Frame Packing 720p	60		—	V	—	V	—
	Side by Side 1080i	50		—	V	—	V	—
	Side by Side 1080i	60		—	V	—	V	—
	Top and Bottom 720p	50		—	V	—	V	—
	Top and Bottom 720p	60		—	V	—	V	—
	Top and Bottom 1080p	24		—	V	—	V	—
Frame sequential 3D	800x600	120		—	V	—	V	—
	1024x768	120		—	V	—	V	—
	1280x720	120		—	V	—	V	—
	1080p	50		—	V	—	V	—
	1080p	60		—	V	—	V	—
	1920X1200RB	50		—	V	—	V	—
	1920X1200RB	60		—	V	—	V	—
SD-SDI	480i YcbCr422 10bit	59.94		—	—	—	—	V
	576i YcbCr422 10bit	50		—	—	—	—	V
HD-SDI	720p YcbCr422 10bit	50		—	—	—	—	V
		59.94		—	—	—	—	V
		60		—	—	—	—	V
	1080i YcbCr422 10bit	50		—	—	—	—	V
		59.94		—	—	—	—	V
		60		—	—	—	—	V
	1080p YcbCr422 10bit	23.98		—	—	—	—	V
		24		—	—	—	—	V
		25		—	—	—	—	V
		29.97		—	—	—	—	V
		30		—	—	—	—	V
		30		—	—	—	—	V
	1080sF YcbCr422 10bit	25		—	—	—	—	V
		29.97		—	—	—	—	V
		30		—	—	—	—	V

ADDITIONAL INFORMATION

Signal Type	Resolution	Frame rate (Hz)	QD881	VGA	HDMI	DVI	HDBaseT	3G-SDI
3GA-SDI	1080p YcbCr422 10bit	50		—	—	—	—	V
		59.94		—	—	—	—	V
		60		—	—	—	—	V
3GB-SDI	1080p YcbCr422 10bit With 352M Payload ID	50		—	—	—	—	V
		59.94		—	—	—	—	V
		60		—	—	—	—	V

Note: “RB” means “reduced blanking”.

EDID Table

OPTOMA	WUXGA	EDID Table
Analog		
Established Timing:	Standard Timing:	Detail Timing:
720 x 400 @ 70 Hz	1440 x 900 @ 75 Hz	1920 x 1200 @ 60 Hz
720 x 400 @ 88 Hz	1280 x 800 @ 75 Hz	1920 x 1080 @ 60 Hz
640 x 480 @ 60 Hz	1280 x 1024 @ 60 Hz	
640 x 480 @ 67 Hz	1360 x 765 @ 60 Hz	
640 x 480 @ 72 Hz	1440 x 900 @ 60 Hz	
640 x 480 @ 75 Hz	1400 x 1050 @ 60 Hz	
800 x 600 @ 56 Hz	1600 x 1200 @ 60 Hz	
800 x 600 @ 60 Hz	1680 x 1050 @ 60 Hz	
800 x 600 @ 72 Hz		
800 x 600 @ 75 Hz		
832 x 624 @ 75 Hz		
1024 x 768 @ 60 Hz		
1024 x 768 @ 70 Hz		
1024 x 768 @ 75 Hz		
1280 x 1024 @ 75 Hz		
1152 x 864 @ 75 Hz		
Digital		
Established Timing:	Standard Timing:	Detail Timing:
720 x 400 @ 70 Hz	1440 x 900 @ 75 Hz	1920 x 1200 @ 60 Hz
720 x 400 @ 88 Hz	1280 x 800 @ 75 Hz	1920 x 1080 @ 60 Hz
640 x 480 @ 60 Hz	1280 x 1024 @ 60 Hz	
640 x 480 @ 67 Hz	1360 x 765 @ 60 Hz	
640 x 480 @ 72 Hz	1440 x 900 @ 60 Hz	
640 x 480 @ 75 Hz	1400 x 1050 @ 60 Hz	
800 x 600 @ 56 Hz	1600 x 1200 @ 60 Hz	
800 x 600 @ 60 Hz	1680 x 1050 @ 60 Hz	
800 x 600 @ 72 Hz		
800 x 600 @ 75 Hz		
832 x 624 @ 75 Hz		
1024 x 768 @ 60 Hz		
1024 x 768 @ 70 Hz		
1024 x 768 @ 75 Hz		
1280 x 1024 @ 75 Hz		
1152 x 864 @ 75 Hz		

ADDITIONAL INFORMATION

OPTOMA	WUXGA	EDID Table
Digital 3D		
Established Timing:	Standard Timing:	Detail Timing:
720 x 400 @ 70 Hz	1024 x 768 @ 120 Hz	1920 x 1200 @ 60 Hz
720 x 400 @ 88 Hz	1280 x 800 @ 75 Hz	1920 x 1080 @ 60 Hz
640 x 480 @ 60 Hz	1280 x 1024 @ 60 Hz	
640 x 480 @ 67 Hz	1360 x 765 @ 60 Hz	
640 x 480 @ 72 Hz	800 x 600 @ 120 Hz	
640 x 480 @ 75 Hz	1400 x 1050 @ 60 Hz	
800 x 600 @ 56 Hz	1600 x 1200 @ 60 Hz	
800 x 600 @ 60 Hz	1680 x 1050 @ 60 Hz	
800 x 600 @ 72 Hz		
800 x 600 @ 75 Hz		
832 x 624 @ 75 Hz		
1024 x 768 @ 60 Hz		
1024 x 768 @ 70 Hz		
1024 x 768 @ 75 Hz		
1280 x 1024 @ 75 Hz		
1152 x 864 @ 75 Hz		

ADDITIONAL INFORMATION

Image size and projection distance

Platform			WUXGA (16:10)												
DMD			0.67"												
Projection Lens			A16	A01	A06	A03	A13	A15							
			Ultra Short Throw	Wide Zoom	Standard	Long Zoom	Ultra-Long Zoom	Short Throw							
Throw Ratio			0.361 (120")	0.95-1.22	1.22-1.52	1.52-2.92	2.90-5.50	0.75-0.95							
Zoom Ratio			N/A	1.28X	1.25X	1.9X	1.9X	1.26X							
Throw Distance			0.93~2.62m	1.02~7.88m	1.32~9.82m	1.64~18.87m	3.12~35.54m	0.81-6.13m							
Projection screen size			Projection distance (m)												
Throw Ratio			0.361 (120")	0.95	1.22	1.22	1.52	1.52	2.92	2.9	5.5	0.75	0.95		
Diagonal (inch)	Height (m)	Width (m)		Min (m)	Max (m)	Min (m)	Max (m)	Min (m)	Max (m)	Min (m)	Max (m)	Min (m)	Max (m)		
50	0.67	1.08	NA	1.02	1.32	1.32	1.64	1.64	3.14	3.12	5.94	0.81	1.03		
60	0.81	1.29	NA	1.23	1.57	1.57	1.96	1.96	3.77	3.74	7.1	0.97	1.23		
70	0.94	1.51	NA	1.43	1.84	1.84	2.30	2.30	4.4	4.38	8.31	1.13	1.43		
80	1.08	1.72	NA	1.64	2.1	2.10	2.61	2.61	5.03	4.99	9.46	1.29	1.63		
90	1.21	1.94	NA	1.84	2.36	2.37	2.95	2.95	5.66	5.63	10.67	1.46	1.84		
100	1.35	2.15	NA	2.05	2.63	2.62	3.27	3.27	6.29	6.24	11.83	1.61	2.04		
110	1.48	2.37	NA	2.25	2.89	2.89	3.60	3.60	6.92	6.87	13.04	1.78	2.25		
120	1.62	2.58	0.96	2.46	3.15	3.15	3.92	3.92	7.55	7.48	14.19	1.94	2.45		
130	1.75	2.8	1.04	2.66	3.42	3.42	4.26	4.26	8.18	8.12	15.4	2.1	2.66		
140	1.88	3.02	1.11	2.86	3.68	3.68	4.59	4.59	8.8	8.76	16.61	2.27	2.87		
150	2.02	3.23	1.18	3.07	3.94	3.94	4.91	4.91	9.43	9.37	17.77	2.42	3.07		
160	2.15	3.45	1.26	3.27	4.2	4.21	5.24	5.24	10.06	10.01	18.98	2.59	3.28		
170	2.29	3.66	1.33	3.48	4.47	4.47	5.56	5.56	10.69	10.61	20.13	2.75	3.48		
180	2.42	3.88	1.40	3.68	4.73	4.73	5.90	5.90	11.32	11.25	21.34	2.91	3.69		
190	2.56	4.09	1.47	3.89	4.99	4.99	6.22	6.22	11.95	11.86	22.5	3.07	3.89		
200	2.69	4.31	1.55	4.09	5.25	5.26	6.55	6.55	12.58	12.5	23.71	3.23	4.09		
250	3.37	5.38	1.91	5.11	6.57	6.56	8.18	8.18	15.72	15.6	29.59	4.04	5.11		
300	4.04	6.46	2.28	6.14	7.88	7.88	9.82	9.82	18.87	18.73	35.54	4.85	6.13		
350	4.71	7.53	2.65	N/A											

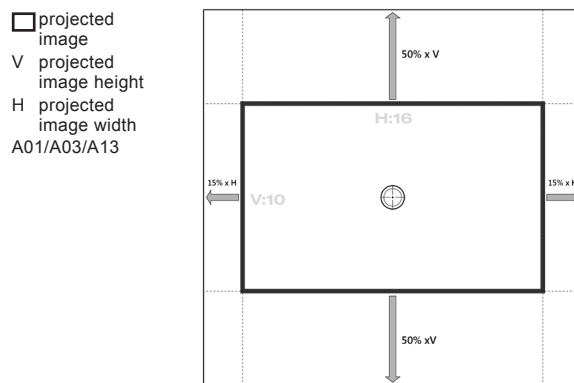
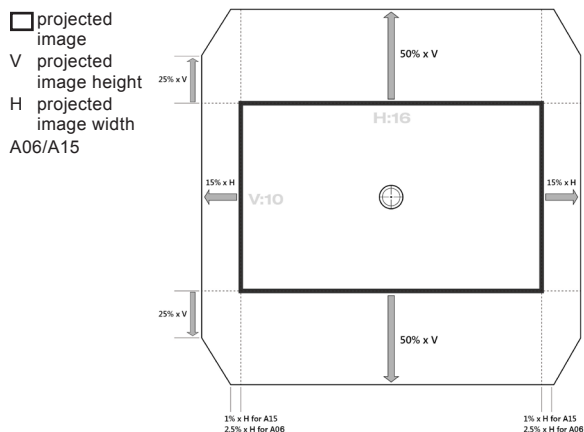

ADDITIONAL INFORMATION

Projector dimensions and ceiling mount installation

1. To prevent damage to your projector, please use the Optoma ceiling mount.
2. If you wish to use a third party ceiling mount kit, please ensure the screws used to attach a mount to the projector meet the following specifications:
 - Screw type: M6 x 4
 - Minimum screw length: 20mm

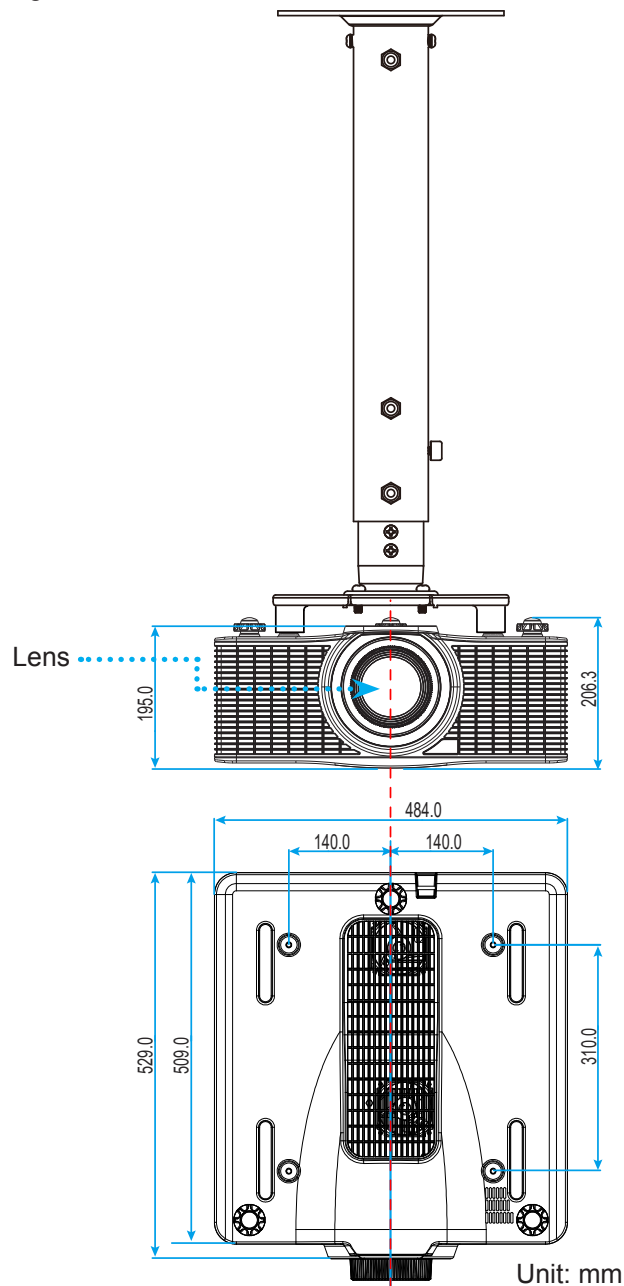

Note: Please note that damage resulting from incorrect installation will void the warranty.



Warning:

- If you buy a ceiling mount from another company, please be sure to use the correct screw size. Screw size will vary depending on the thickness of the mounting plate.
- Be sure to keep at least 30mm (3cm) gap between the ceiling and the bottom of the projector.
- Avoid installing the projector near a heat source.

ADDITIONAL INFORMATION

IR remote codes



Key Legend	Key Position	Repeat Format	Address		Data		Description
			Byte 1	Byte 2	Byte 3	Byte 4	
ON (🟢)	1	F1	32	CD	02	FD	Press to turn on the projector.
OFF (🔴)	2	F1	32	CD	2E	D1	Press to turn off the projector.
1	3	F1	32	CD	72	8D	Use as numeric keypad number "1".
2	4	F1	32	CD	73	8C	Use as numeric keypad number "2".
3	5	F1	32	CD	74	8B	Use as numeric keypad number "3".
4	6	F1	32	CD	75	8A	Use as numeric keypad number "4".
5	7	F1	32	CD	77	88	Use as numeric keypad number "5".

ADDITIONAL INFORMATION

Key Legend	Key Position	Repeat Format	Address		Data		Description
			Byte 1	Byte 2	Byte 3	Byte 4	
6	8	F1	32	CD	78	87	Use as numeric keypad number "6".
7	9	F1	32	CD	79	86	Use as numeric keypad number "7".
8	10	F1	32	CD	80	7F	Use as numeric keypad number "8".
9	11	F1	32	CD	81	7E	Use as numeric keypad number "9".
Info	12	F1	32	CD	82	7D	Press to display source image information.
0	13	F1	32	CD	25	DA	Use as numeric keypad number "0".
Mode	14	F1	32	CD	05	FA	Press to select the preset display mode.
Auto	15	F1	32	CD	04	FB	Press to automatically synchronize the projector to the input source.
Input	16	F1	32	CD	18	E7	Press to select an input signal.
UP (▲)	17	F1	32	CD	0F	F0	Press to select items or make adjustments to our selection.
LEFT (◀)	18	F1	32	CD	11	EE	Press to select items or make adjustments to our selection.
Enter	19	F1	32	CD	14	EB	Press to confirm your item selection.
RIGHT (▶)	20	F1	32	CD	10	EF	Press to select items or make adjustments to our selection.
DOWN (▼)	21	F1	32	CD	12	ED	Press to select items or make adjustments to our selection.
Menu	22	F1	32	CD	0E	F1	Press to display the on-screen display menus for projector.
Exit	23	F1	32	CD	2A	D5	Press to return to previous level or exit menus if at top level.
Gamma	24	F1	32	CD	2B	D4	Press to adjust mid-range levels..
Bright	25	F1	32	CD	28	D7	Press to adjust amount of light in the image.
Cont.	26	F1	32	CD	29	D6	Press to adjust difference between dark and light.
PIP	27	F1	32	CD	43	BC	Press to turn on/off the PIP/PBP function.
Lens H ◀	28	F1	32	CD	41	BE	Press to adjust the position of the image horizontally.
Lens H ▶	29	F1	32	CD	42	BD	
Focus ▲	30	F1	32	CD	86	79	Press to adjust focus to improve image clarity as desired.
Lens V ▲	31	F1	32	CD	34	CB	Press to adjust the position of the image vertically.
Lens V ▼	32	F1	32	CD	32	CD	Press to adjust the position of the image vertically.
Focus ▼	33	F1	32	CD	26	D9	Press to adjust focus to improve image clarity as desired.
Keystone ▽	34	F1	32	CD	87	78	Press to adjust the vertical keystone.
Keystone ▽	35	F1	32	CD	51	AE	Press to adjust the vertical keystone.

ADDITIONAL INFORMATION







Key Legend	Key Position	Repeat Format	Address		Data		Description
			Byte 1	Byte 2	Byte 3	Byte 4	
Zoom ▲	36	F1	32	CD	52	AD	Press to adjust zoom to achieve a desired image size.
Keystone ◻	37	F1	32	CD	53	AC	Press to adjust the horizontal keystone.
Keystone ◻	38	F1	32	CD	54	AB	Press to adjust the horizontal keystone.
Zoom ▼	39	F1	32	CD	55	AA	Press to adjust zoom to achieve a desired image size.
Shutter (AV Mute)	40	F1	32	CD	56	A9	Press to hide/unhide the screen picture.
Hot Key	41	F1	32	CD	57	A8	Press to select your preset keys quickly.
Pattern	42	F1	32	CD	58	A7	Press to display a test pattern.

ADDITIONAL INFORMATION

Troubleshooting

If you experience a problem with your projector, please refer to the following information. If a problem persists, please contact your local reseller or service center.

Image problems

-  *No image appears on-screen*
- Ensure all the cables and power connections are correctly and securely connected as described in the "Installation" section.
 - Ensure the pins of connectors are not crooked or broken.
 - Ensure that the "Shutter (AV Mute)" feature is not turned on.
-  *Image is out of focus*
- Press the **Focus ▲** or **Focus ▼** button on the remote control to adjust the focus until the image is sharp and legible.
 - Make sure the projection screen is between the required distance from the projector. (Please refer to page 58).
-  *The image is stretched when displaying 16:10 DVD title*
- When you play anamorphic DVD or 16:10 DVD, the projector will show the best image in 16:10 format on projector side.
 - If you play 4:3 format DVD title, please change the format as 4:3 in projector OSD.
 - Please setup the display format as 16:10 (wide) aspect ratio type on your DVD player.
-  *Image is too small or too large*
- Press the **Zoom ▲** or **Zoom ▼** button on the remote control to increase or decrease the projected image size.
 - Move the projector closer to or further from the screen.
 - Press "Menu" on the projector panel, go to "OUTPUT-->Aspect Ratio". Try the different settings.
-  *Image has slanted sides:*
- If possible, reposition the projector so that it is centered on the screen and below the bottom of the screen.
 - Use "OUTPUT-->Image Warping-->V Keystone" from the OSD to make an adjustment.
-  *Image is reversed*
- Select "SETUP-->Rear Projection-->On" from the OSD to reverse the image so you can project from behind a translucent screen.

Other problems

ADDITIONAL INFORMATION

 *The projector stops responding to all controls*

- If possible, turn off the projector, then unplug the power cord and wait at least 20 seconds before reconnecting power.

Remote control problems

 *If the remote control does not work*

- Check the operating angle of the remote control is pointed within $\pm 30^\circ$ (horizontally or vertically) to the IR receivers on the projector.
- Make sure there are not any obstructions between the remote control and the projector. Move to within 10 m (32.8 ft) of the projector.
- Make sure batteries are inserted correctly.
- Replace batteries if they are exhausted.

Warning indicators

LED status indicators

The LED status indicators are located on the rear of the projector. Each LED is defined below.

Message	Light LED			Status LED			AV Mute LED	
	Green	Orange	Red	Green	Orange	Red	Green	Orange
Standby State (Indicate on Power key)	—	—	—	—	—	—	—	—
Power on (Warm up)	—	—	—	—	Flashing	—	—	—
Power on & Laser diode on	Steady	—	—	Steady	—	—	Steady	—
Power off (Cooling down)	—	—	—	—	Flashing	—	—	—
AV mute is off (Image is displayed)	Steady	—	—	Steady	—	—	Steady	—
AV mute is on (Image is black)	Steady	—	—	Steady	—	—	—	Steady
Projector communication	Steady	—	—	Flashing	—	—	Steady	—
Firmware upgrade	—	—	—	Flashing	Flashing	—	—	—
Laser diode time has expired	—	Steady	—	—	—	—	—	—
Unit loses over 60% initial luminance	—	—	Flashing	—	—	—	—	—
Error (Over temperature)	—	—	—	—	—	Steady	—	—
Error (Fan failure)	—	—	—	—	—	Flashing	—	—

Note: Keypad LED (Power Key) will flash in orange for standby mode.

ADDITIONAL INFORMATION

- Power off:

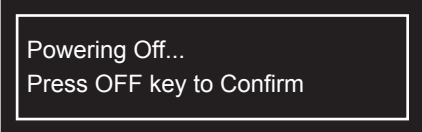

Powering Off...
Press OFF key to Confirm

- Light power impact due to high ambient temperature:

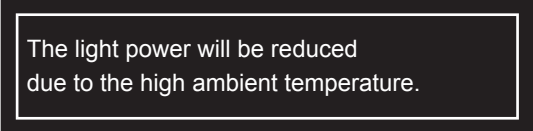

The light power will be reduced
due to the high ambient temperature.

- DMD life time impact due to high ambient temperature:

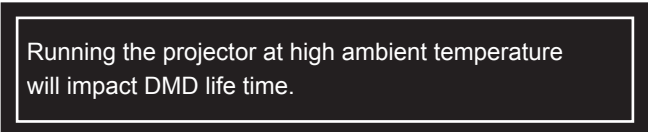

Running the projector at high ambient temperature
will impact DMD life time.

LAN Control Setting:

LAN Control	Port
AMX	9131
Crestron	41794
PJ-Link	4352
Telnet	23
Http	80

ADDITIONAL INFORMATION

Specifications

Optical	Description
Resolution	WUXGA (1920x1200)
Lens	Power Zoom/Focus
Laser Diode	35W@3A (Normal Mode)
Image size (diagonal)	50~300"
Projection distance	Please refer to "Image size and projection distance" table on page 58

Electrical	Description
Inputs	1 x HDMI (version 1.4) (with locking screw) 1 x DVI-D (only support digital signal) 1 x VGA IN (D-Sub 15pin) (Computer In) 1 x HDBaseT 1 x 3D SYNC IN 1 x 3G-SDI
Outputs	1 x HDMI (version 1.4) (with locking screw) 1 x VGA Out (Support VGA loops through to monitor) (Monitor Out) 1 x 3D SYNC Out
Control port	1 x RS232 (D-sub 9 pin) (PC Control) 1 x Wired in (3.5mm phone jack) (Remote In) 1 x USB type A (for WiFi dongle purpose) 1 x Mini USB (for LAN FW upgrade only) (Service) 1 x RJ45 (LAN)
Power requirement	AC 100V - 240V, 50/60Hz
Input current	6.5A - 2.5A

Mechanical	Description
Installation orientation	Table Top, Ceiling Mount, Portrait (360 degree orientation)
Dimensions	484 (W) x 509 (D) x 185 (H) mm (without lens, w/o elevators)
Weight	18.5 kg
Environmental conditions	Operating: 5~40°C (>35°C, auto dim to 75% normal mode), 10~85%RH, non-condensing

Note: All specifications are subject to change without notice.



ADDITIONAL INFORMATION

Optoma global offices

For service or support, please contact your local office.



USA

3178 Laurelview Ct.
Fremont, CA 94538, USA
www.optomausa.com

 888-289-6786
 510-897-8601
 services@optoma.com



Canada

3178 Laurelview Ct.
Fremont, CA 94538, USA
www.optomausa.com

 888-289-6786
 510-897-8601
 services@optoma.com



Latin America

3178 Laurelview Ct.
Fremont, CA 94538, USA
www.optomausa.com

 888-289-6786
 510-897-8601
 services@optoma.com



Europe

Unit 1, Network 41, Bourne End Mills
Hemel Hempstead, Herts,
HP1 2UJ, United Kingdom
www.optoma.eu
Service Tel : +44 (0)1923 691865

 +44 (0) 1923 691 800
 +44 (0) 1923 691 888
 service@tsc-europe.com



Benelux BV

Randstad 22-123
1316 BW Almere
The Netherlands
www.optoma.nl

 +31 (0) 36 820 0252
 +31 (0) 36 548 9052



France

Bâtiment E
81-83 avenue Edouard Vaillant
92100 Boulogne Billancourt, France

 +33 1 41 46 12 20
 +33 1 41 46 94 35
 savoptoma@optoma.fr



Spain

C/ José Hierro,36 Of. 1C
28522 Rivas VaciaMadrid,
Spain

 +34 91 499 06 06
 +34 91 670 08 32



Deutschland

Wiesenstrasse 21 W
D40549 Düsseldorf,
Germany

 +49 (0) 211 506 6670
 +49 (0) 211 506 66799
 info@optoma.de

Scandinavia



Lerpeveien 25
3040 Drammen
Norway

 +47 32 98 89 90
 +47 32 98 89 99
 info@optoma.no

PO.BOX 9515
3038 Drammen
Norway

Korea

WOOMI TECH.CO.,LTD.
4F, Minu Bldg.33-14, Kangnam-Ku,
Seoul,135-815, KOREA
korea.optoma.com

 +82+2+34430004
 +82+2+34430005



Japan

東京都足立区綾瀬3-25-18
株式会社オーエス
コンタクトセンター:0120-380-495

 info@os-worldwide.com
www.os-worldwide.com



Taiwan

12F., No.213, Sec. 3, Beixin Rd.,
Xindian Dist., New Taipei City 231,
Taiwan, R.O.C.
www.optoma.com.tw

 +886-2-8911-8600
 +886-2-8911-6550
 services@optoma.com.tw
asia.optoma.com



Hong Kong

Unit A, 27/F Dragon Centre,
79 Wing Hong Street,
Cheung Sha Wan,
Kowloon, Hong Kong

 +852-2396-8968
 +852-2370-1222
www.optoma.com.hk

China

5F, No. 1205, Kaixuan Rd.,
Changning District
Shanghai, 200052, China

 +86-21-62947376
 +86-21-62947375
www.optoma.com.cn

