



DLP[®] Projector

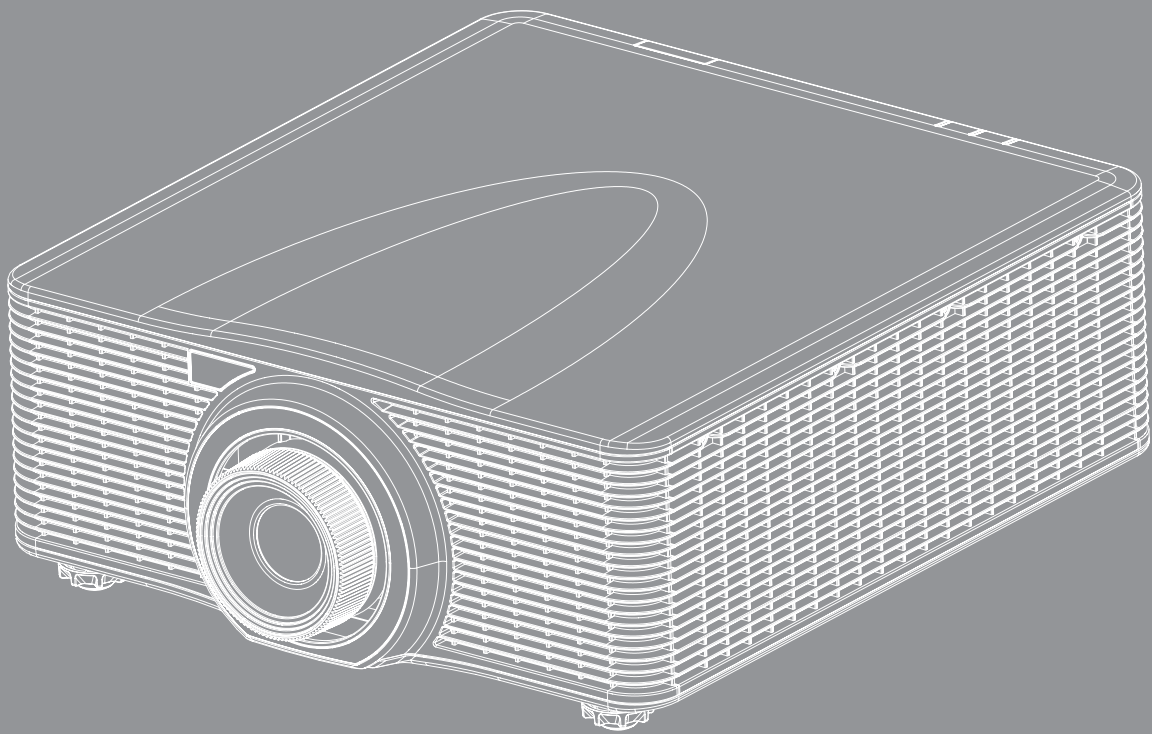

TABLE OF CONTENTS

SAFETY	4
<i>Important Safety Instruction.....</i>	<i>4</i>
<i>Laser Radiation Safety Information</i>	<i>5</i>
<i>Copyright</i>	<i>6</i>
<i>Disclaimer.....</i>	<i>6</i>
<i>Trademark Recognition</i>	<i>6</i>
<i>FCC</i>	<i>6</i>
<i>Declaration of Conformity for EU countries</i>	<i>7</i>
<i>WEEE.....</i>	<i>7</i>
INTRODUCTION.....	8
<i>Package Overview.....</i>	<i>8</i>
<i>Standard accessories</i>	<i>8</i>
<i>Optional accessories</i>	<i>8</i>
<i>Product Overview</i>	<i>9</i>
<i>Connections.....</i>	<i>10</i>
<i>Keypad</i>	<i>11</i>
<i>Remote control.....</i>	<i>12</i>
SETUP AND INSTALLATION.....	13
<i>Installing the projection lens</i>	<i>13</i>
<i>Adjusting the projector position</i>	<i>15</i>
<i>Connecting sources to the projector.....</i>	<i>16</i>
<i>Adjusting the projector image.....</i>	<i>17</i>
<i>Remote setup</i>	<i>18</i>
USING THE PROJECTOR.....	20
<i>Powering on / off the projector.....</i>	<i>20</i>
<i>Selecting an input source</i>	<i>21</i>
<i>Menu navigation and features</i>	<i>22</i>
<i>OSD Menu tree.....</i>	<i>23</i>
<i>Picture menu</i>	<i>30</i>
<i>Screen menu</i>	<i>34</i>
<i>Settings menu.....</i>	<i>39</i>
<i>Light source menu</i>	<i>40</i>
<i>Options menu</i>	<i>41</i>
<i>3D menu.....</i>	<i>43</i>
<i>Communications menu.....</i>	<i>44</i>
<i>Setup network control settings menu</i>	<i>46</i>

ADDITIONAL INFORMATION 51

<i>Compatible resolutions</i>	51
<i>Image size and projection distance</i>	56
<i>Projector dimensions and ceiling mount installation</i>	57
<i>IR remote codes</i>	58
<i>Troubleshooting</i>	60
<i>Warning indicators</i>	61
<i>Specifications</i>	63
<i>Optoma global offices</i>	64

SAFETY

	The lightning flash with arrow head within an equilateral triangle is intended to alert the user to the presence of uninsulated "dangerous voltage" within the product's enclosure that may be of sufficient magnitude to constitute a risk of electric shock to persons.
	The exclamation point within an equilateral triangle is intended to alert the user to the presence of important operating and maintenance (servicing) instructions in the literature accompanying the appliance.

Please follow all warnings, precautions and maintenance as recommended in this user's guide.

Important Safety Instruction

- Do not block any ventilation openings. To ensure reliable operation of the projector and to protect from over heating, it is recommended to install the projector in a location that does not block ventilation. As an example, do not place the projector on a crowded coffee table, sofa, bed, etc. Do not put the projector in an enclosure such as a book case or a cabinet that restricts air flow.
- To reduce the risk of fire and/or electric shock, do not expose the projector to rain or moisture. Do not install near heat sources such as radiators, heaters, stoves or any other apparatus such as amplifiers that emits heat.
- Do not let objects or liquids enter the projector. They may touch dangerous voltage points and short out parts that could result in fire or electric shock.
- Do not use under the following conditions:
 - In extremely hot, cold or humid environments.
 - (i) Ensure that the ambient room temperature is within 5°C ~ 40°C
 - (ii) Relative humidity is 10% ~ 85%
 - In areas susceptible to excessive dust and dirt.
 - Near any appliance generating a strong magnetic field.
 - In direct sunlight.
- Do not use the projector in places where flammable gases or explosives gases may be present in the atmosphere. The lamp inside the projector becomes very hot during operation and the gases may ignite and result in a fire.
- Do not use the unit if it has been physically damaged or abused. Physical damage/abuse would be (but not limited to):
 - Unit has been dropped.
 - Power supply cord or plug has been damaged.
 - Liquid has been spilled on to the projector.
 - Projector has been exposed to rain or moisture.
 - Something has fallen in the projector or something is loose inside.
- Do not place the projector on an unstable surface. The projector may fall over resulting in injury or the projector may become damaged.
- Do not block the light coming out of the projector lens when in operation. The light will heat the object and cause melt, burns or start a fire.
- Please do not open or disassemble the projector as this may cause electric shock.
- Do not attempt to service the unit yourself. Opening or removing covers may expose you to dangerous voltages or other hazards. Please call Optoma before you send the unit for repair.
- See projector enclosure for safety related markings.
- The unit should only be repaired by authorized service personnel.

- Only use attachments/accessories specified by the manufacturer.
- Do not look into straight into the projector lens during operation. The bright light may harm your eyes.
- This projector will detect the life of the lamp itself.
- When switching the projector off, please ensure the cooling cycle has been completed before disconnecting power. Allow 90 seconds for the projector to cool down.
- Turn off and unplug the power plug from the AC outlet before cleaning the product.
- Use a soft dry cloth with mild detergent to clean the display housing. Do not use abrasive cleaners, waxes or solvents to clean the unit.
- Disconnect the power plug from AC outlet if the product is not being used for a long period of time.
- Do not setup the projector in places where it might be subjected to vibration or shock.
- Do not touch the lens with bare hands.
- Remove battery/batteries from remote control before storage. If the battery/batteries are left in the remote for long periods, they may leak.
- Do not use or store the projector in places where smoke from oil or cigarettes may be present, as it can adversely affect the quality of the projector performance.
- Please follow the correct projector orientation installation as non standard installation may affect the projector performance.
- Use a power strip and or surge protector. As power outages and brown-outs can KILL devices.

Laser Radiation Safety Information

This product is classified as CLASS 1 LASER PRODUCT - RISK GROUP 2 of IEC 60825-1 : 2014 and also complies with 21 CFR 1040.10 and 1040.11 as a Risk Group 2 , LIP (Laser Illuminated Projector) as defined in IEC 62471:2006 except for deviations pursuant to Laser Notice No. 50, dated June 24, 2007.



Failure to comply with the following could result in death or serious injury.

- This projector has a built-in Class 4 laser module. Never attempt to disassemble or modify the projector.
- Any operation or adjustment not specifically instructed in the User manual creates the risk of hazardous laser radiation exposure.
- Do not open or disassemble the projector as this may cause damage or exposure to laser radiation.
- Do not stare into beam when the projector is on. The bright light may result in permanent eye damage.
- When turning on the projector, make sure no one within projection range is looking into the lens.
- Follow the control, adjustment, or operation procedures to avoid damage or injury from exposure of laser radiation.
- The instructions for the assembly, operation, and maintenance include clear warnings concerning precautions to avoid possible exposure to hazardous laser radiation.

Copyright

This publication, including all photographs, illustrations and software, is protected under international copyright laws, with all rights reserved. Neither this manual, nor any of the material contained herein, may be reproduced without written consent of the author.

© Copyright 2018

Disclaimer

The information in this document is subject to change without notice. The manufacturer makes no representations or warranties with respect to the contents hereof and specifically disclaims any implied warranties of merchantability or fitness for any particular purpose. The manufacturer reserves the right to revise this publication and to make changes from time to time in the content hereof without obligation of the manufacturer to notify any person of such revision or changes.

Trademark Recognition

Kensington is a U.S. registered trademark of ACCO Brand Corporation with issued registrations and pending applications in other countries throughout the world.

HDMI, the HDMI Logo, and High-Definition Multimedia Interface are trademarks or registered trademarks of HDMI Licensing LLC in the United States and other countries.

DLP®, DLP Link and the DLP logo are registered trademarks of Texas Instruments and BrilliantColor™ is a trademark of Texas Instruments.

HDBaseT™ and the HDBaseT Alliance logo are trademarks of the HDBaseT Alliance.

All other product names used in this manual are the properties of their respective owners and are Acknowledged.

FCC

This device has been tested and found to comply with the limits for a Class A digital device pursuant to Part 15 of the FCC rules. These limits are designed to provide reasonable protection against harmful interference in a residential installation. This device generates, uses and can radiate radio frequency energy and, if not installed and used in accordance with the instructions, may cause harmful interference to radio communications.

However, there is no guarantee that interference will not occur in a particular installation. If this device does cause harmful interference to radio or television reception, which can be determined by turning the device off and on is encouraged to try to correct the interference by one or more of the following measures:

- Reorient or relocate the receiving antenna.
- Increase the separation between the device and receiver.
- Connect the device into an outlet on a circuit different from that to which the receiver is connected.
- Consult the dealer or an experienced radio/television technician for help.

Notice: Shielded cables

All connections to other computing devices must be made using shielded cables to maintain compliance with FCC regulations.

Caution

Changes or modifications not expressly approved by the manufacturer could void the user's authority, which is granted by the Federal Communications Commission, to operate this projector.

Operation Conditions

This device complies with Part 15 of the FCC Rules. Operation is subject to the following two conditions:

1. This device may not cause harmful interference and
2. This device must accept any interference received, including interference that may cause undesired operation.

Notice: Canadian users

This Class A digital apparatus complies with Canadian ICES-003.

Remarque à l'intention des utilisateurs canadiens

Cet appareil numérique de la classe A est conforme à la norme NMB-003 du Canada.

Declaration of Conformity for EU countries

- EMC Directive 2014/30/EU (including amendments)
- Low Voltage Directive 2014/35/EU
- Radio Equipment Directive 2014/53/EU (if product has RF function)
- RoHS Directive 2011/65/EU

WEEE**Disposal instructions**

Do not throw this electronic device into the trash when discarding. To minimize pollution and ensure utmost protection of the global environment, please recycle it.

INTRODUCTION

Package Overview

Carefully unpack and verify that you have the items listed below under standard accessories. Some of the items under optional accessories may not be available depending on the model, specification and your region of purchase. Please check with your place of purchase. Some accessories may vary from region to region.

The warranty card is only supplied in some specific regions. Please consult your dealer for detailed information.

Standard accessories

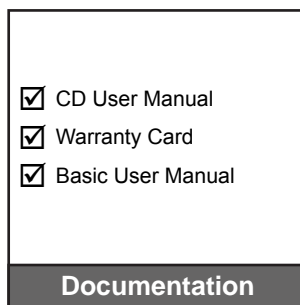
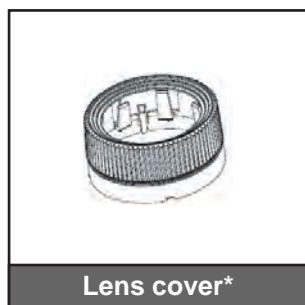
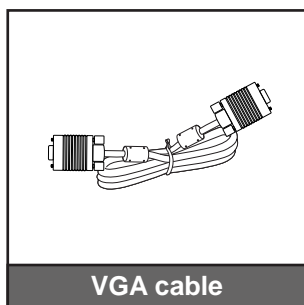
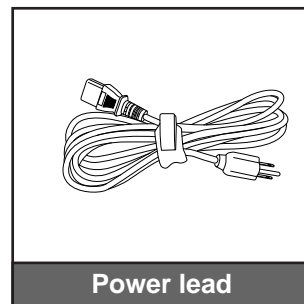
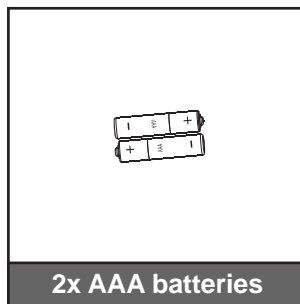
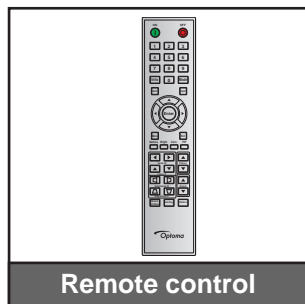
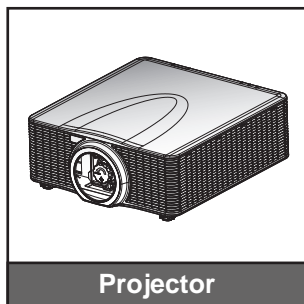

Optional accessories

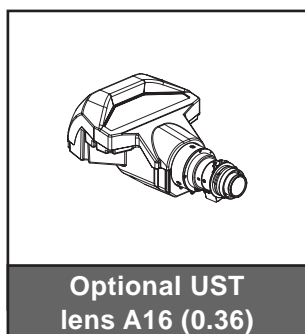
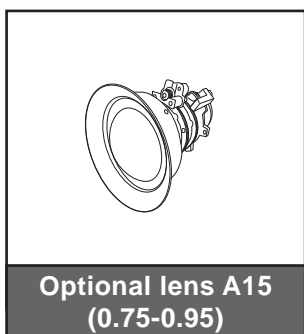
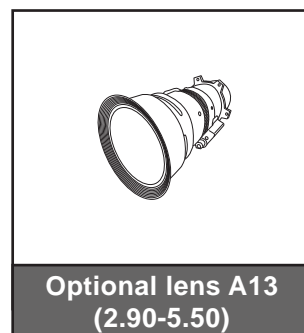
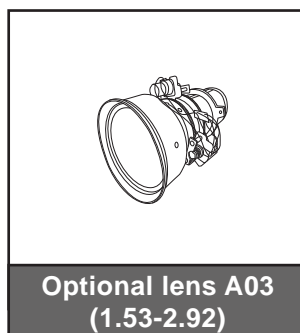
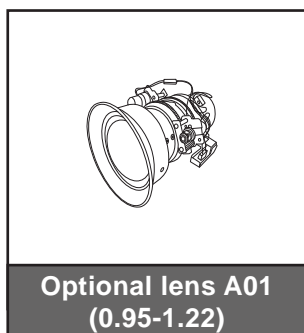

Note:

- Optional accessories vary depending on model, specification and region.
- *For A01, A03, and A13 lens.

INTRODUCTION

Product Overview

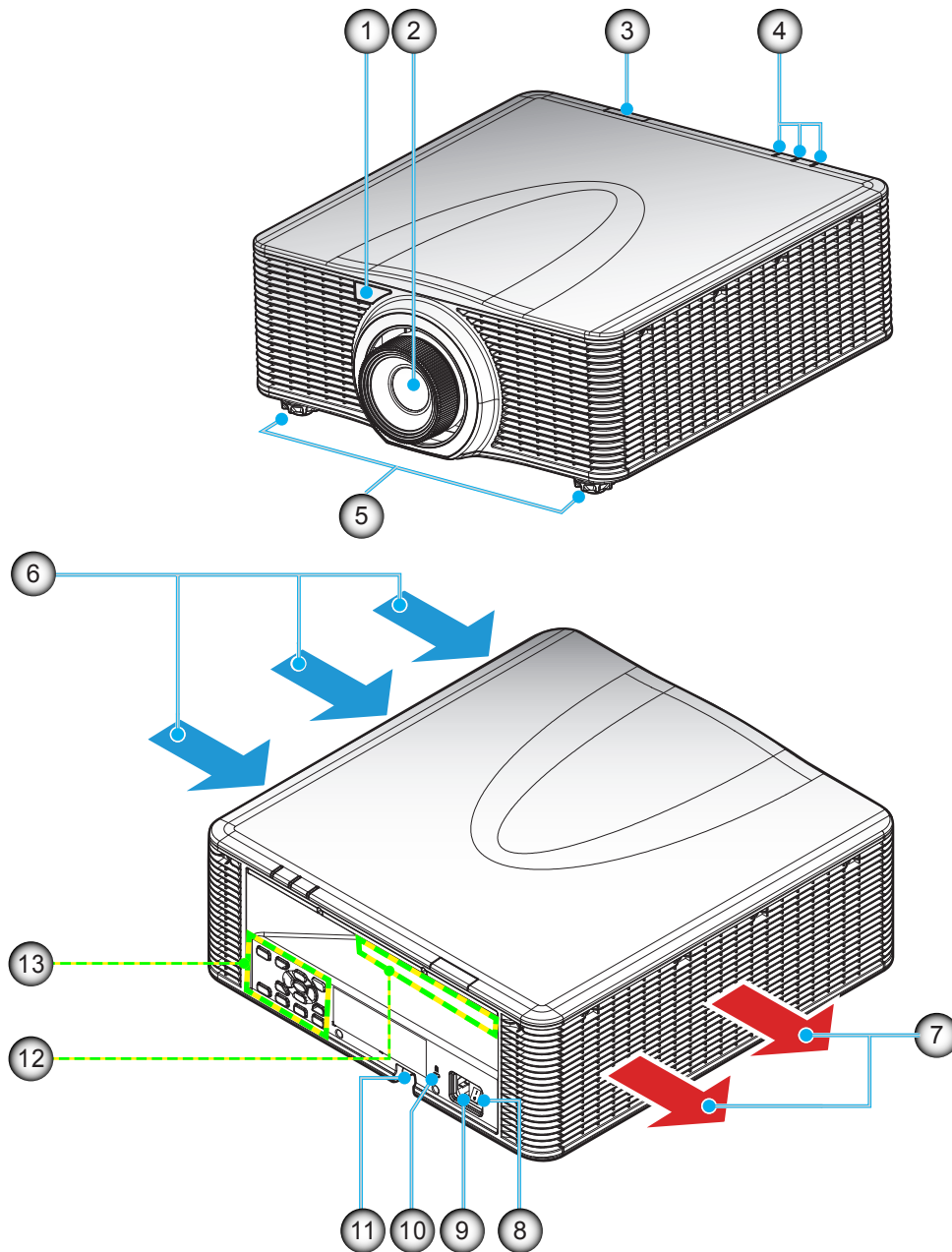

Note: Do not block projector inlet or outlet air vents.

(*) optional accessory varies depending on model, specification, and region.

No	Item	No	Item
1.	Front IR Receiver	8.	Power Switch
2.	Lens	9.	Power Socket
3.	Top IR Receiver	10.	Kensington™ Lock Port
4.	LED Status Indicators	11.	Security Bar
5.	Tilt-Adjustment Feet	12.	Input / Output
6.	Ventilation (inlet)	13.	Keypad
7.	Ventilation (outlet)		

INTRODUCTION

Connections

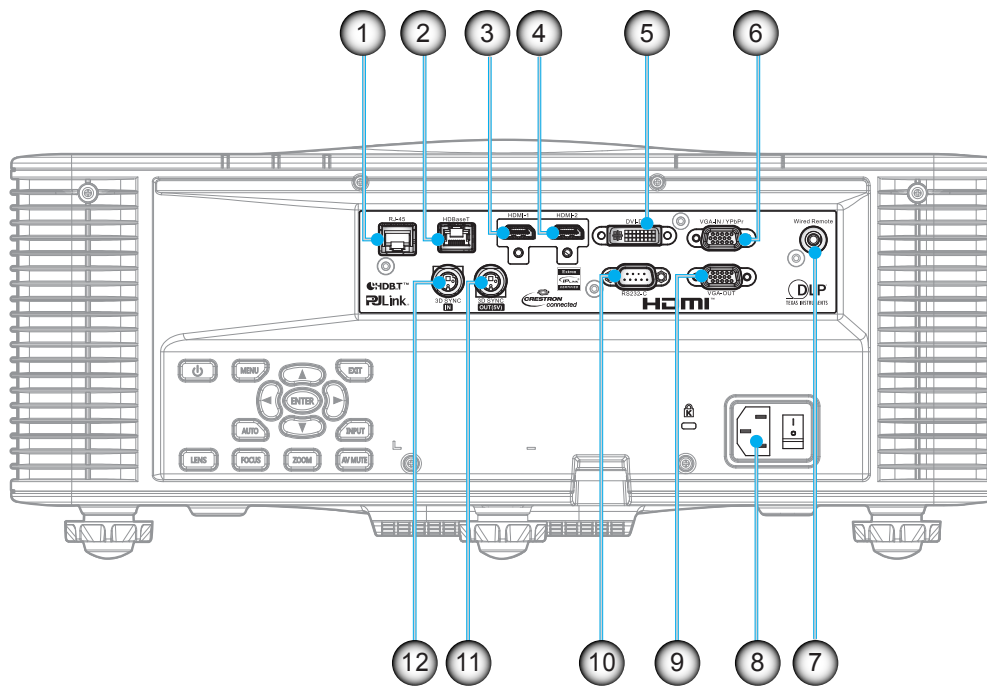

No	Item	No	Item
1.	LAN Connector	7.	Wired Remote Connector
2.	HDBaseT Connector	8.	Power Socket
3.	HDMI-1 Connector	9.	VGA-OUT Connector
4.	HDMI-2 Connector	10.	RS232-C Connector
5.	DVI-D Connector	11.	3D SYNC OUT Connector
6.	VGA-IN/YPbPr Connector	12.	3D SYNC IN Connector

INTRODUCTION

Keypad

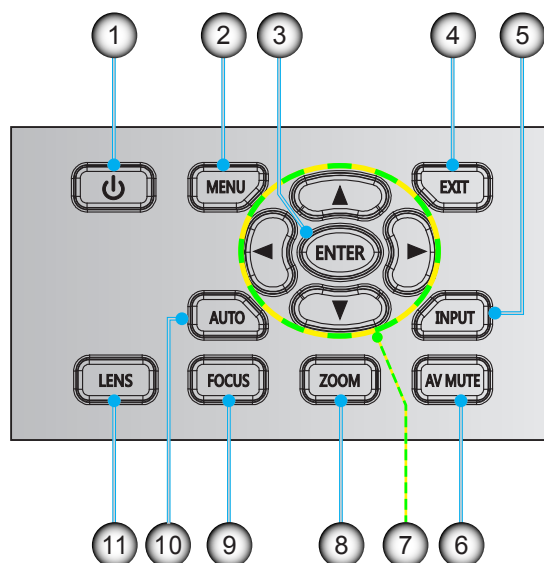

No	Item	No	Item
1.	Power	7.	Four Directional Select Keys
2.	Menu	8.	Zoom
3.	Enter	9.	Focus
4.	Exit	10.	Auto
5.	Input	11.	Lens
6.	AV Mute		

INTRODUCTION

Remote control

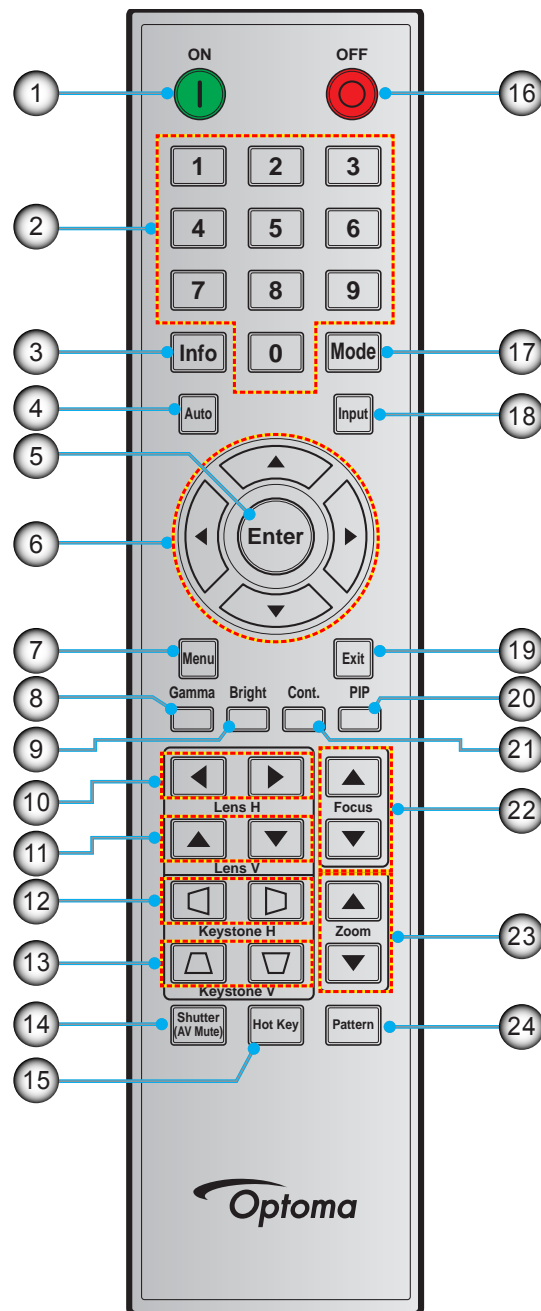

No	Item	No	Item	No	Item
1.	Power On	9.	Bright	17.	Mode
2.	Number Keys	10.	Lens H	18.	Input
3.	Info	11.	Lens V	19.	Exit
4.	Auto	12.	Keystone H	20.	PIP
5.	Enter	13.	Keystone V	21.	Cont.
6.	Four Directional Select Keys	14.	Shutter (AV Mute)	22.	Focus
7.	Menu	15.	Hot Key	23.	Zoom
8.	Gamma	16.	Power Off	24.	Pattern

SETUP AND INSTALLATION

Installing the projection lens

Before setting up the projector, install the projection lens on the projector.

在安装或替换镜头前，关掉投影机的电源。

在镜头安装联接过程中，避免使用遥控器或投影机按键板的按钮调节侧平移镜头或缩放/聚焦。

Before install or replacing the lens, switch off the power to the projector.

Avoid using the remote control or projector keypad button to adjust the lens shift or zoom/focus while the lens attachment process is carried out.

IMPORTANT!

- *Make sure the projector is properly turned off before installing the lens.*
- *During lens installation, do not adjust the lens shift, zoom, or focus either using the remote control or the projector keypad.*

Procedure:

1. Rotate the lens cap counterclockwise.

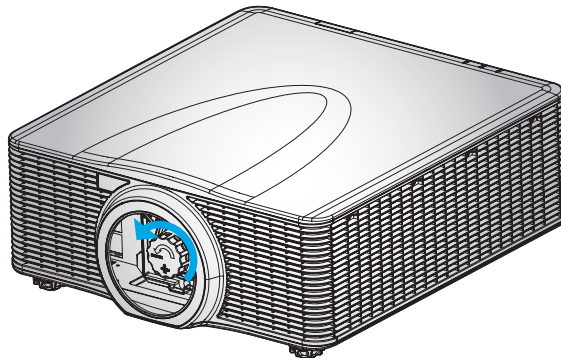

2. Remove the lens cap.

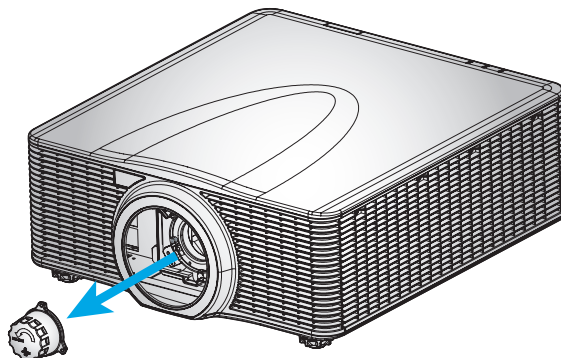

SETUP AND INSTALLATION

3. Install the lens onto the projector.

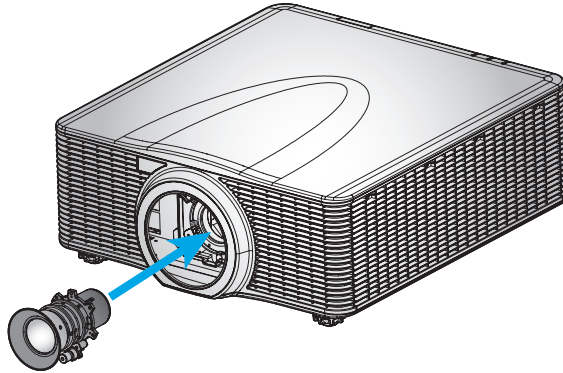

4. Rotate the lens clockwise to lock the lens in place.

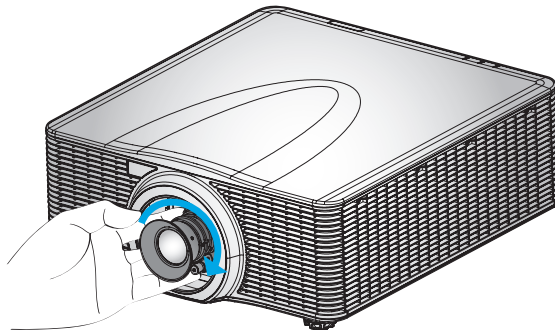

5. Firmly install the lens ring onto the lens.

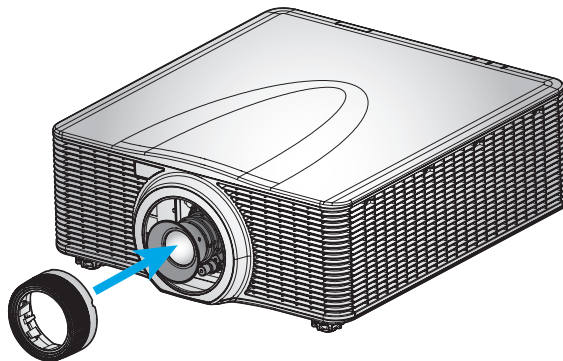

Note: The lens ring is compatible with the following lens modules: A01 (0.95-1.22), A02 (1.22-1.53), A03 (1.53-2.92), and A13 (2.90-5.50).

SETUP AND INSTALLATION

Adjusting the projector position

When you select a position for the projector, consider the size and shape of your screen, the location of your power outlets, and the distance between the projector and the rest of your equipment. Follow these general guidelines:

- Position the projector on a flat surface at a right angle to the screen. The projector (with the standard lens) must be at least 3 feet (0.9m) from the projection screen.
- Position the projector to the desired distance from the screen. The distance from the lens of the projector to the screen, the zoom setting, and the video format determine the size of the projected image.
- For the fixed short lens, the image exits at a default angle. However, the lens shift feature makes the image offset variable.
- 360 degree free orientation operation

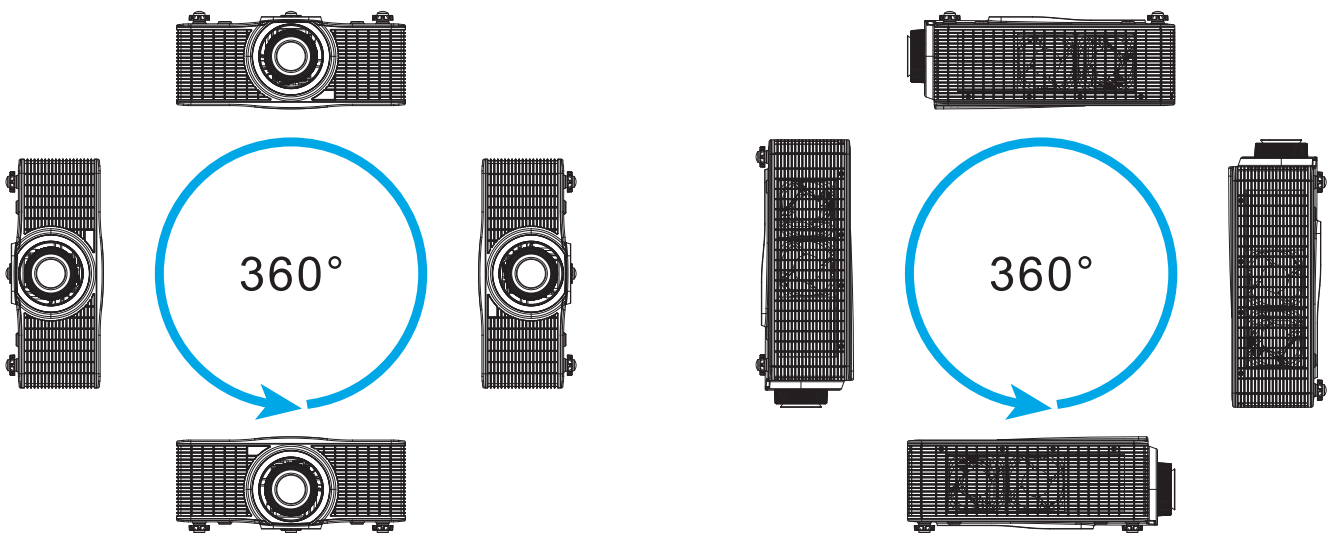

SETUP AND INSTALLATION

Connecting sources to the projector

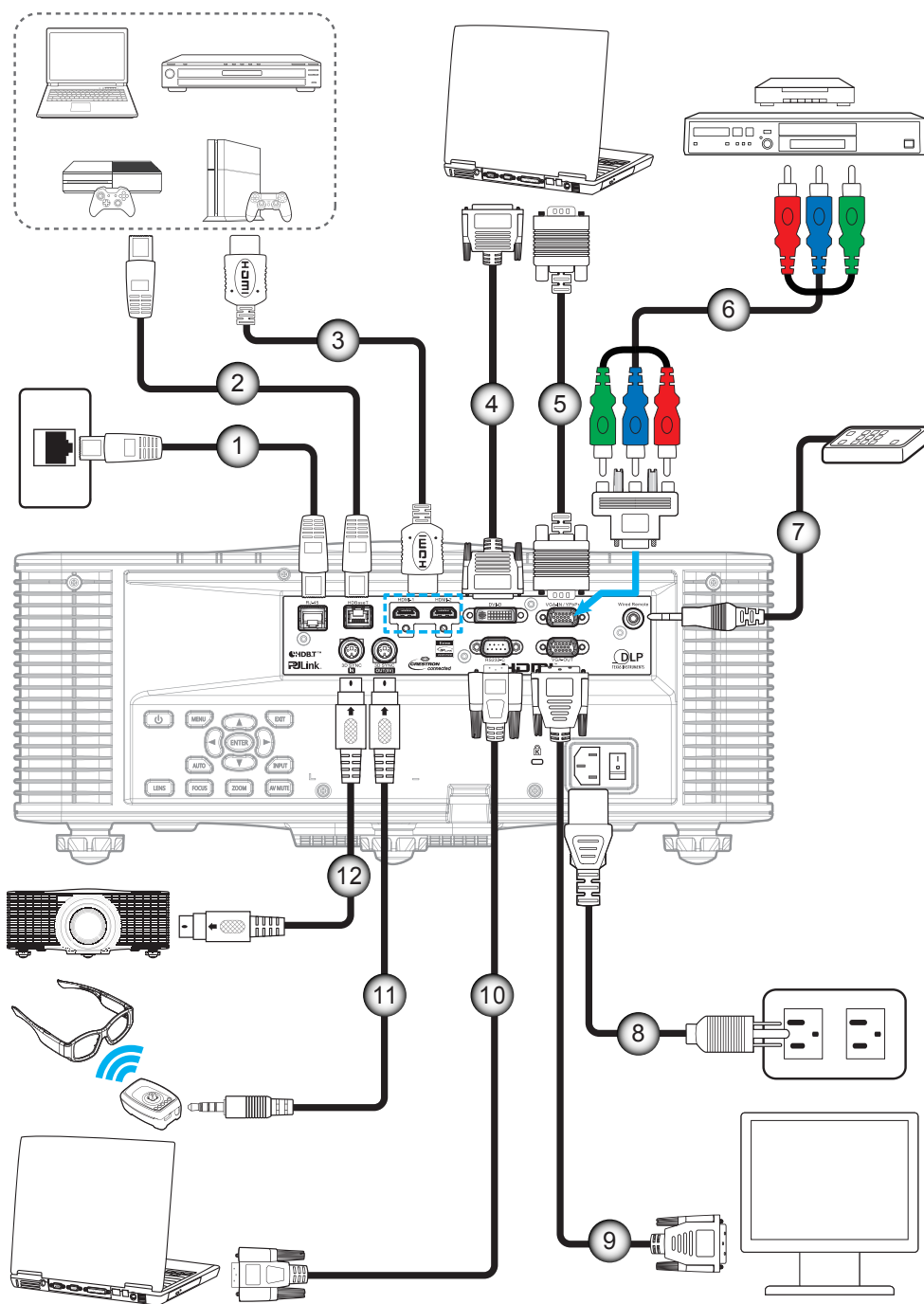

No	Item	No	Item
1.	RJ-45 Cable	7.	Wired Remote-In Cable (~30m)
2.	CAT5e/6/6A Cable	8.	Power Cord
3.	HDMI Cable	9.	VGA-Out Cable
4.	DVI-D Cable	10.	RS-232C Cable
5.	VGA-In Cable	11.	3D Emitter Cable
6.	RCA Component Cable	12.	3D Sync Cable

SETUP AND INSTALLATION

Adjusting the projector image

Image height

The projector is equipped with elevator feet for adjusting the image height.

1. Locate the adjustable foot you wish to adjust on the underside of the projector.
2. Rotate the adjustable foot clockwise or counterclockwise to raise or lower the projector.

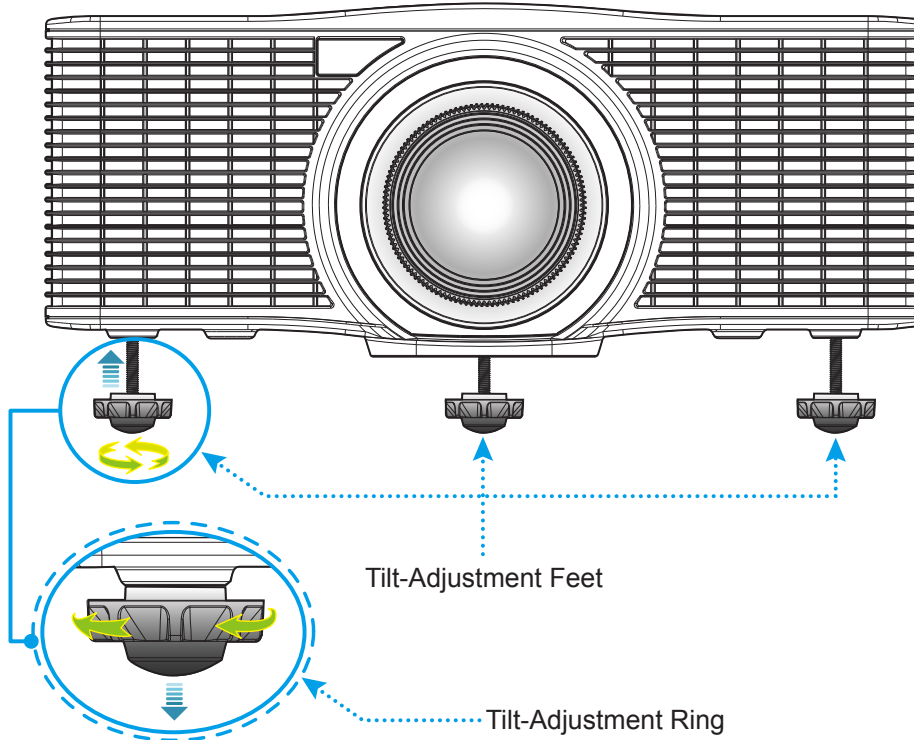

Warning:

- The feet of projector are not removable. Please do not screw out the feet of projector. The adjustable height of the elevator feet could be raised up to 45mm.

Zoom and focus

- To adjust the image size, press the **Zoom** button (A) to increase or decrease the projected image size.
- To adjust the focus, press the **Focus** button (B) until the image is sharp and legible.

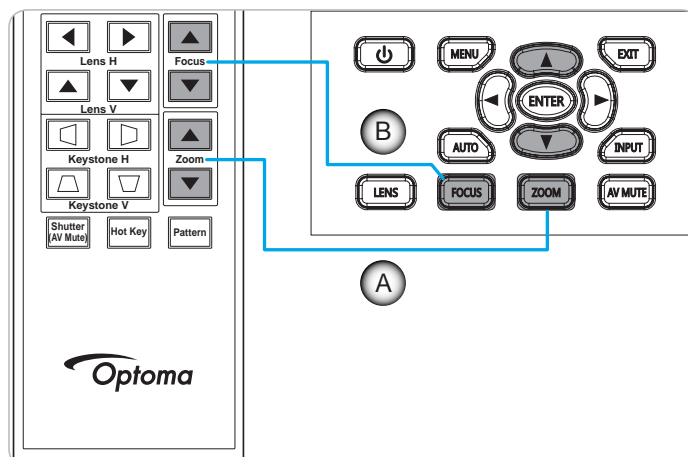

SETUP AND INSTALLATION

Remote setup

Installing / replacing the batteries

Two AAA size batteries are supplied for the remote control.

1. Remove the battery cover on the back of the remote control.
2. Insert AAA batteries in the battery compartment as illustrated.
3. Replace back cover on remote control.

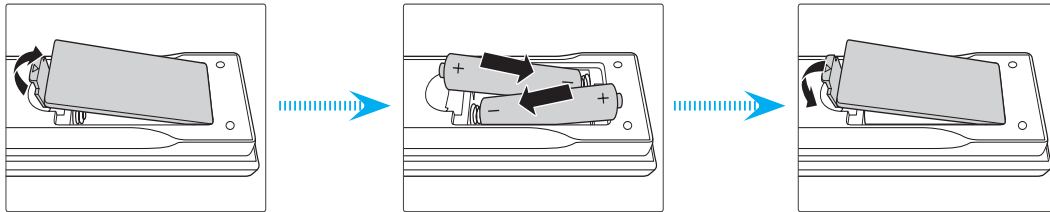

Note: Replace only with the same or equivalent type batteries.

CAUTION

Improper use of batteries can result in chemical leakage or explosion. Be sure to follow the instructions below.

- Do not mix batteries of different types. Different types of batteries have different characteristics.
- Do not mix old and new batteries. Mixing old and new batteries can shorten the life of new batteries or cause chemical leakage in old batteries.
- Remove batteries as soon as they are depleted. Chemicals that leak from batteries that come in contact with skin can cause a rash. If you find any chemical leakage, wipe thoroughly with a cloth.
- The batteries supplied with this product may have a shorter life expectancy due to storage conditions.
- If you will not be using the remote control for an extended period of time, remove the batteries.
- When you dispose of the batteries, you must obey the law in the relative area or country.

Effective range

Infra-Red (IR) remote control sensors are located on the front and top sides of the projector. Ensure to hold the remote control at an angle within $\pm 30^\circ$ (horizontally or vertically) to the projector's IR remote control sensor to function correctly. The distance between the remote control and the sensor should not be longer than 10 meters (32.8 feet).

- Make sure that there are no obstacles between the remote control and the IR sensor on the projector that might obstruct the infra-red beam.
- Make sure the IR transmitter of the remote control is not being shined by sunlight or fluorescent lamps directly.
- Please keep the remote controller away from fluorescent lamps for over 2 m or the remote controller might become malfunction.
- If the remote control is closed to Inverter-Type fluorescent lamps, it might become ineffective from time to time.
- If the remote control and the projector are within a very short distance, the remote control might become ineffective.
- When you aim at the screen, the effective distance is less than 5 m from the remote control to the screen and reflecting the IR beams back to the projector. However, the effective range might change according to screens.

SETUP AND INSTALLATION

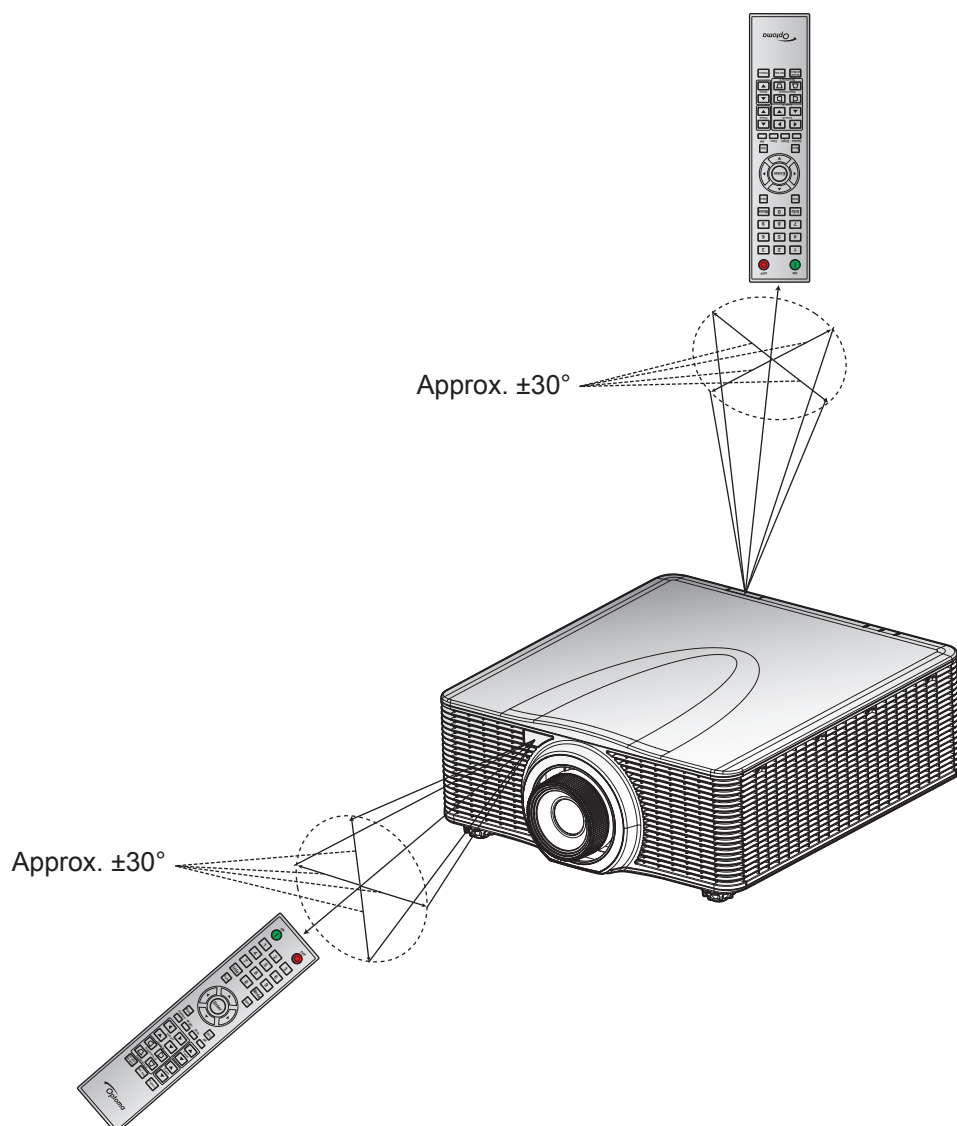

USING THE PROJECTOR

Powering on / off the projector

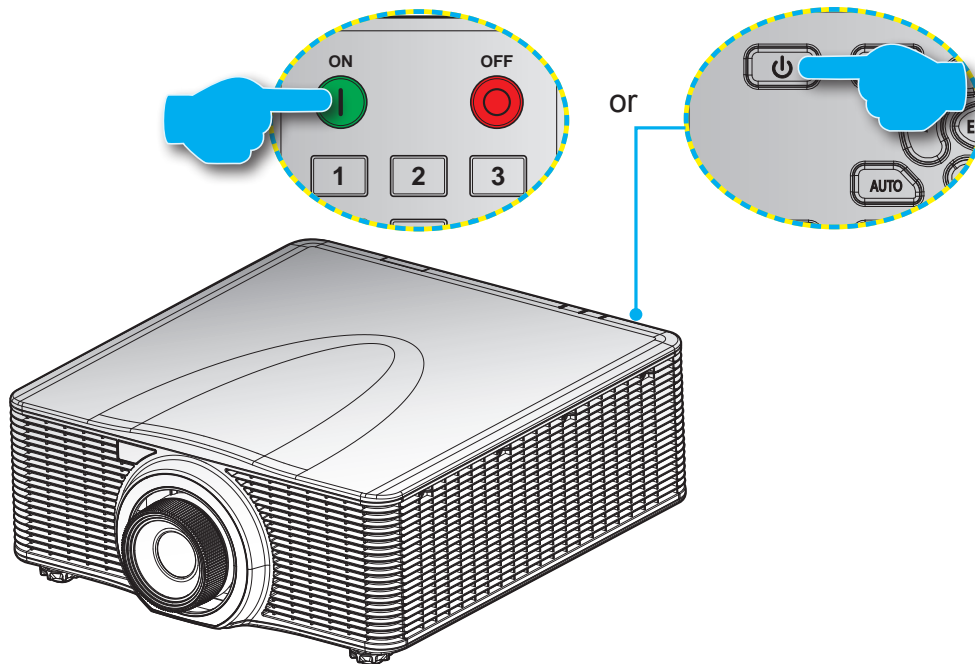



Powering on

1. Securely connect the power lead and signal/source cable.
2. Set the **Power** switch to the “ON” position.
3. Turn on the projector by pressing “

Note: The first time the projector is turned on, you will be prompted to select the preferred language, projection orientation, and other settings.

Powering off

1. Turn off the projector by pressing “

2. Press “

Note: It is not recommended that the projector is turned on immediately, right after a power off procedure.

USING THE PROJECTOR

Selecting an input source

Turn on the connected source that you want to display on the screen, such as computer, notebook, video player, etc. The projector will automatically detect the source. If multiple sources are connected, press the **Input** button on the projector keypad or the remote control to select the desired input.

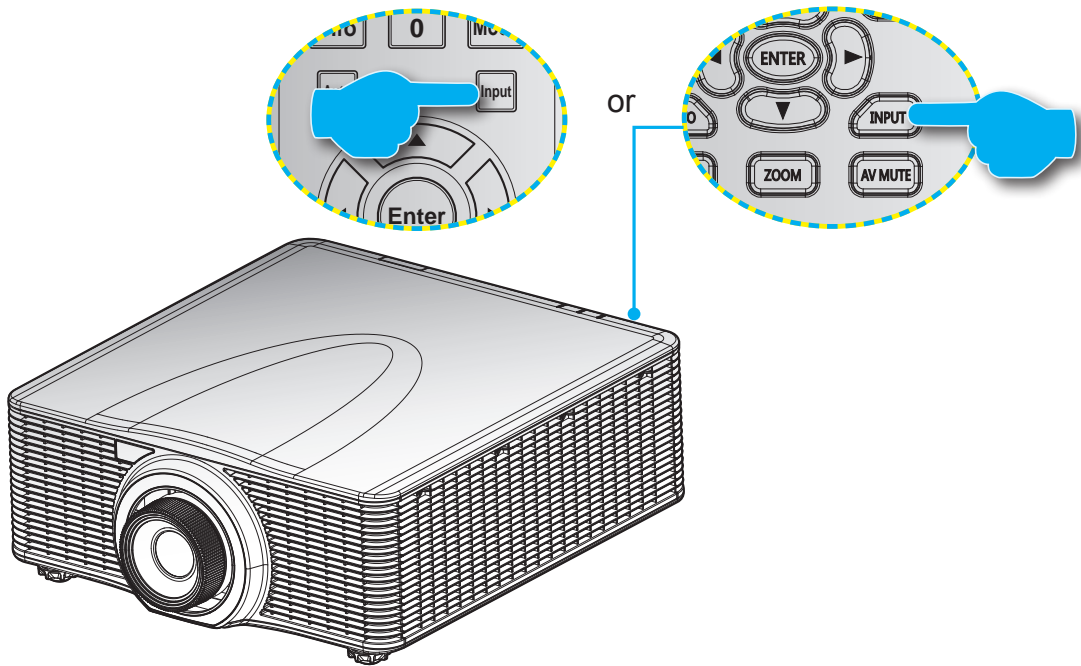

USING THE PROJECTOR

Menu navigation and features

The projector has multilingual on-screen display menus that allow you to make image adjustments and change a variety of settings. The projector will automatically detect the source.

1. To open the OSD menu, press "Menu" on the remote control or the projector keypad.
2. When OSD is displayed, use ▲▼◀▶ to navigate within the menu and adjust a setting up or down.
3. Press "Enter" to enter the submenu or confirm the selection/setting.
4. Press "Exit" to return to the previous menu or exit menus if at top level.

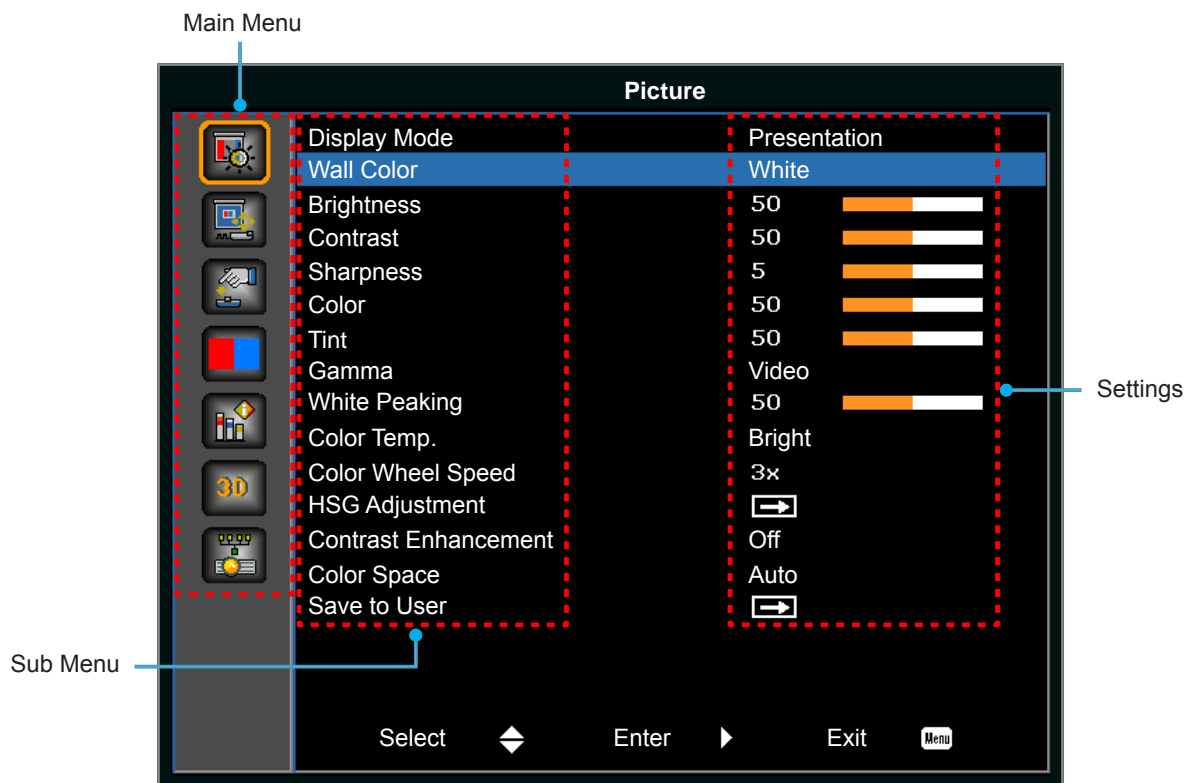

USING THE PROJECTOR

OSD Menu tree

Main Menu	Sub Menu	Sub Menu 2	Sub Menu 3	Default Value	Range	
Picture	Display Mode	Bright		Depends on signal type and selected Color Mode.		
		Presentation				
		Movie				
		sRGB				
		Blending				
		DICOM SIM.				
		User				
	Wall color	White		White		
		Gray 130				
	Brightness			Depends on Color Mode.	0 ~ 100	
	Contrast			Depends on Color Mode.	0 ~ 100	
	Sharpness			5	0 ~ 10	
	Color			For VGA component signal only.	0 ~ 100	
	Tint			For VGA component signal only.	0 ~ 100	
	Gamma	Video		Depends on Color Mode.		
		Film				
		Bright				
		CRT				
		DICOM				
	White Peaking				0 ~ 100	
	Color Temp.	Warm		Bright		
		Bright				
		Cool				
	Color Wheel Speed	2X			3X	
		3X				
	HSG Adjustment	Red		Hue		1~199
				Saturation		0 ~ 199
				Gain		1 ~ 199
		Green		Hue		1~199
				Saturation		0 ~ 199
				Gain		1 ~ 199
		Blue		Hue		1~199
			Saturation		0 ~ 199	
			Gain		1 ~ 199	
Cyan			Hue		1~199	
			Saturation		0 ~ 199	
			Gain		1 ~ 199	
Magenta		Hue		1~199		
		Saturation		0 ~ 199		
		Gain		1 ~ 199		

USING THE PROJECTOR

Main Menu	Sub Menu	Sub Menu 2	Sub Menu 3	Default Value	Range	
Picture	HSG Adjustment	Yellow	Hue		1~199	
			Saturation		0 ~ 199	
			Gain		1 ~ 199	
		White Gain	Red		1~199	
			Green			
			Blue			
	Reset to Default					
	Contrast Enhancement	Off		Off		
		Dynamic Black				
		Extreme Black				
	Color Space	Auto		Auto		
		RGB (0-255)				
		RGB (16-235)				
		YUV				
	Save to User	Yes				
No						
Screen	Aspect Ratio	Auto				
		4:3				
		16:9				
		16:10				
		Native				
	Pixel Phase			Analog signal only.	0 ~ 100	
	Pixel Track			Analog signal only.	0 ~ 100	
	Horz Position			Analog signal only.	0 ~ 100	
	Vert Position			Analog signal only.	0 ~ 100	
	Digital Horz Zoom	100% to 200%		0	0 ~ 10	
	Digital Vert Zoom	100% to 200%		0	0 ~ 10	
	Digital Horz Shift			50	0 ~ 100	
	Digital Vert Shift			50	0 ~ 100	
	Ceiling Mount	Off		Auto		
		On				
		Auto				
	Rear Projection	Off		Off		
		On				
	Geometric Correction	H. Keystone			20	0 ~ 40
			V. Keystone		20	0 ~ 40
4-Corner			Top Left Horz Adjust			
			Top Left Vert Adjust			
			Top Right Horz Adjust			
			Top Right Vert Adjust			
	Bottom Left Horz Adjust					

USING THE PROJECTOR

Main Menu	Sub Menu	Sub Menu 2	Sub Menu 3	Default Value	Range	
Screen	Geometric Correction	4-Corner	Bottom Left Vert Adjust			
			Bottom Right Horz Adjust			
			Bottom Right Vert Adjust			
		Grid Color	Purple	Green		
			Green			
		Reset	Yes			
	No					
	PIP-PBP	PIP / PBP Enable	Off	Off		
			PBP			
			PIP			
		Main Source	VGA	Current source.		
			HDMI-1			
			HDMI-2			
			DVI			
			HDBaseT			
		Sub Source	VGA	Depends on current source.		
			HDMI-1			
			HDMI-2			
			DVI			
			HDBaseT			
		Layout	Top Left	Top Left		
			Top Right			
			Bottom Left			
			Bottom Right			
		Size	Small	Medium		
	Medium					
	Large					
	Swap					
	Source key	Change Sources				
		List all Sources				
		Auto Source				
	Auto Image	Normal	Wide			
Wide						
Source Info	Active Source					
	Signal Format					
	Aspect Ratio					
	Resolution					
	Vert Refresh					
	Horz Refresh					
	Pixel Clock					
	Sync Type					
Color Space						

USING THE PROJECTOR

Main Menu	Sub Menu	Sub Menu 2	Sub Menu 3	Default Value	Range
Screen	Source Info	PIP/PBP (When PIP/PBP is active)			
		<PIP/PBP source lines> (When PIP/PBP is active)			
Settings	Language	English		English	
		Simplified Chinese			
		French			
		German			
		Italian			
		Japanese			
		Korean			
		Russian			
		Spanish			
		Portuguese			
		Indonesian			
		Dutch			
	Menu Location	Left Top 		Left Top	
		Right Top 			
		Center 			
		Left Bottom 			
		Right Bottom 			
	Standby Power Mode	0.5W mode		Communication	
		Communication mode			
	Test Pattern	None		None	
		Grid			
		White			
		Black			
		Checkerboard			
		Color Bars			
	Direct Power On	Off / On		Off	
	Signal Power On	Off / On		Off	
Hot-Key settings	Blank Screen		Blank Screen		
	Aspect Ratio				
	Freeze Screen				
	Projector Info				
Reset to Default	Yes				
	No				
Service					
Light source	Light Source Mode	Constant Power		Constant Power	
		Constant Intensity			
		ECO 1			
		ECO 2			
	Constant Power	0 to 99		99	0 to 99 (30% to 100%)

USING THE PROJECTOR

Main Menu	Sub Menu	Sub Menu 2	Sub Menu 3	Default Value	Range	
Light source	Light Source Info	Total Projector Hours				
		LD Hours				
Options	Background color	Logo		Default Value		
		Blue				
		Black				
		White				
	Auto shutdown			0	0~120 (one step: 5 mins)	
	Sleep Timer			0	0~990 (one step: 10 mins)	
	Lens Function	Focus	Command		Focus in - motor go step	
					Focus out - motor go step	
		Zoom	Command		Zoom in - motor go step	
					Zoom out - motor go step	
		Lens Shift	Command		Left shift up - motor go step	
					Left shift down - motor go step	
					Left shift right - motor go step	
					Left shift left - motor go step	
		Lens Memory	Apply Position		1	
					2	
					3	
					4	
					5	
			Save Current Position		1	
					2	
					3	
					4	
					5	
	Lock Lens Motors	Allow	Allow			
		Locked				
	Lens Calibration	Command				
	High Altitude	Off		Off		
		On				
	PIN	PIN protect	Off	Off		
			On			
		Change PIN				
Remote Settings	Top	Off	On			
		On				
	Front	Off	On			
		On				
	HDBaseT	Off	On			
On						
Projector Address	0 ~ 99	0				
Show message	Off		Off			
	On					

USING THE PROJECTOR

Main Menu	Sub Menu	Sub Menu 2	Sub Menu 3	Default Value	Range
Options	LED Settings	Keypad LED	Always On	Always On	
			Always Off		
		Status LED	Always On	Always On	
			Always Off		
			Warnings/Errors Only		
		Information	Model Name		
	Serial Number				
	Native Resolution				
	MCU FW				
	DDP FW				
	M9813 FW				
	Motor FW				
	ext flash FW				
	Main Input				
	Main Signal Format				
	Main Pixel Clock				
	Main Sync Type				
	Main Horz Refresh				
	Main Vert Refresh				
	PIP/PBP Input				
	PIP/PBP Signal Format				
	PIP/PBP Pixel Clock				
	PIP/PBP Sync Type				
	PIP/PBP Horz Refresh				
	PIP/PBP Vert Refresh				
	Light Source Power				
	Total Projector Hours				
	Light Source Hours				
	Standby Mode				
	Lens Lock Settings				
	IP Address				
	DHCP				
	System Temperature				

USING THE PROJECTOR

Main Menu	Sub Menu	Sub Menu 2	Sub Menu 3	Default Value	Range
3D	3D	Auto		Auto	
		On			
	3D Invert	Off		Off	
		On			
	3D Format	Frame Packing		Depends on input signal. If an HDMI source is detected with AVINFO then 3D mode is switched on automatically.	
		Side-by-Side (Half)			
		Top and Bottom			
		Frame Sequential			
	1080p @ 24	96Hz		144Hz	
		144Hz			
	3D sync out	To Emitter		To Emitter	
		To Next Projector			
Frame Delay				1~200	
L/R Reference	1ST Frame		1ST Frame		
	Field GPIO				
DLP Link	Off		Off		
	On				
Communications	LAN	DHCP		By set.	
		IP Address			
		Subnet Mask			
		Default Gateway			
		MAC Address			
		Apply	Command		
	Network	Projector Name		By set.	
		Show Network Messages	On		
			Off		
		Restart Network...	Command		
	Network Factory Reset...	Command			
	Serial Port Baud Rate	1200		115200	
		2400			
		4800			
		9600			
		14400			
		19200			
		38400			
		57600			
		115200			
Serial Port Echo	Off		Off		
	On				
Serial Port Path	RS232		RS232		
	HDBaseT				

USING THE PROJECTOR

Picture menu

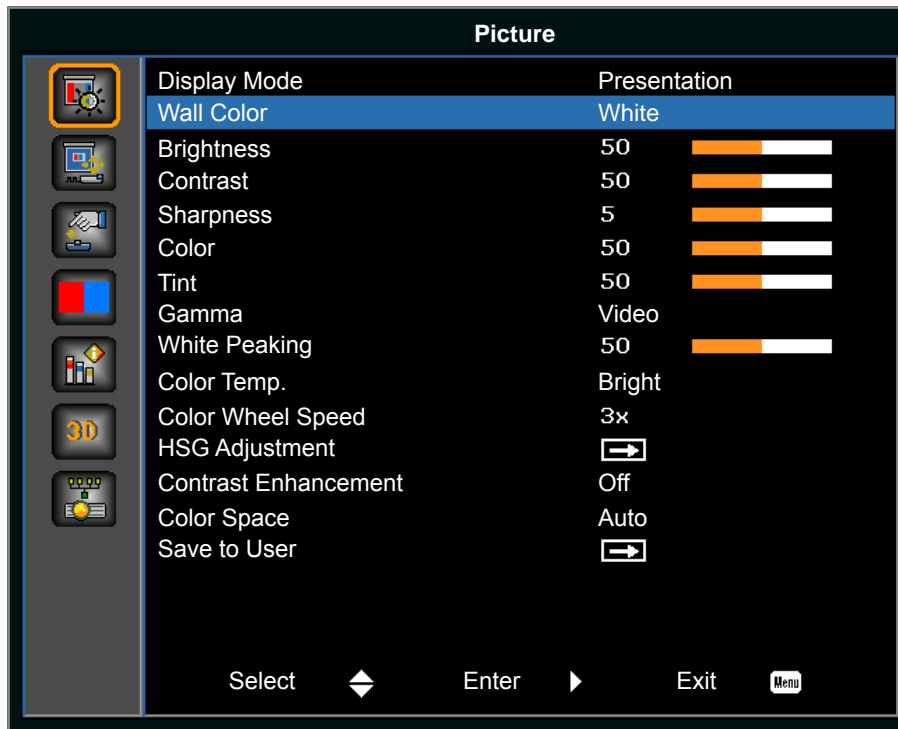

Display Mode

Optimize the projector for displaying images under certain conditions.

- **Bright:** Maximum brightness from PC input.
- **Presentation:** This mode is suitable for showing PowerPoint presentations when the projector is connected to the PC.
- **Movie:** This mode is suitable for watching video.
- **sRGB:** This color mode matches the REC709 color standard as closely as possible.
- **Blending:** When using multiple projectors, this mode can eliminate the visible banding and create a single bright, high resolution image across the screen.
- **DICOM SIM:** This mode can project a monochrome medical image such as an X ray radiography, MRI, etc.
- **User:** Memorize user's settings.

Wall Color

Set the wall color so that the projector can enhance the color performance customized for the specific wall. Available options include White and Gray 130.

Brightness

Adjust the intensity of the image.

Contrast

Adjust the degree of difference between the lightest and darkest parts of the image and change the amount of black and white in the image.

Sharpness

Adjust the sharpness of the image.

USING THE PROJECTOR

Color

Adjust a video image from black and white to fully saturated color.

Tint

Adjust the color balance of red and green.

Gamma

Set up gamma curve type. After the initial setup and fine tuning is completed, utilize the gamma adjustment steps to optimize your image output.

- **Video:** For video or TV source.
- **Film:** For home theater.
- **Bright:** For emphasizing brightness.
- **CRT:** For CRT monitor.
- **DICOM:** For simulated DICOM.

White Peaking

Increase the brightness of whites near 100%.

Color Temp.

Change the intensity of the colors. Select a listed relative warmth value.

Color Wheel Speed

Select the color wheel speed from 2x or 3x. The color wheel speed defines the delay between the color wheel and the DMD.

HSG Adjustment

For more information on HSG adjustment, refer to page 31.

Contrast Enhancement

Enable or disable the contrast enhancement function. Enable this function to raise the contrast ratio.

- **Off:** Disable contrast enhancement function.
- **Dynamic Black:** Auto adjust the contrast ratio for video contents.
- **Extreme Black:** Auto increase contrast when a blank (black) image is displayed.

Color Space

Select a color space specifically tuned for the input signal. Only useful for analog signals and certain digital sources. The available options include Auto, RGB (0-255), RGB (16-235), and YUV.

Save to User

Save the current picture settings in user profile.

HSG Adjustment menu

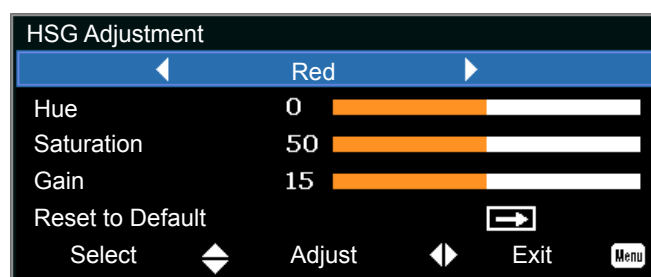

USING THE PROJECTOR

Hue

Note the following about adjusting hue:

- Adjust the hue independently for each color (R,G,B,C,M, and Y).
- White does not have a hue input.
- A negative hue input provides a clockwise rotation of the color's hue.
- A positive hue input provides a counter-clockwise rotation of the color's hue.
- A zero input does not change the hue of the color.

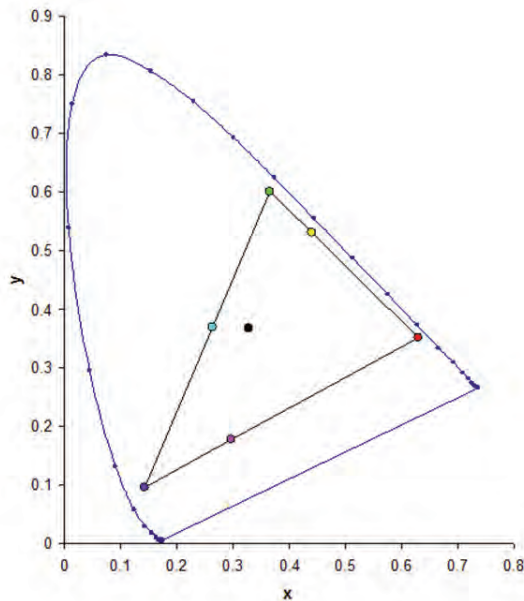

Saturation

Note the following about adjusting saturation:

- The saturation can be adjusted independently for each color (R,G,B,C,M, and Y).
- A saturation level of 0 removes all color from that region.
- A saturation level of 254 sets the color region to have maximum color.
- A saturation level of 127 does not change the saturation.

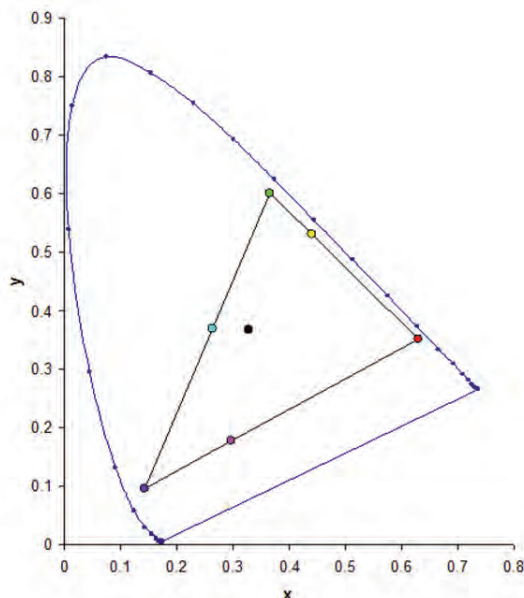

USING THE PROJECTOR

Gain

Note the following about adjusting gain:

- The gain can be adjusted independently for each color (R,G,B,C,M,Y, and W).
- The range of input is 0 to 254.
- The gain changes the intensity level of the respective color.
- A gain level of 127 disables the HSG controls for that color.
- A gain level less than 127 darkens the respective color.
- A gain level of 254 sets the color region to have maximum gain; however, clipping occurs on the signal.
- A gain of 127 is the nominal setting.
- White provides three gain level controls, one each for the R,G,B component of white.

Reset to Default

Reset all the HSG adjustments to the factory defaults.

USING THE PROJECTOR

Screen menu

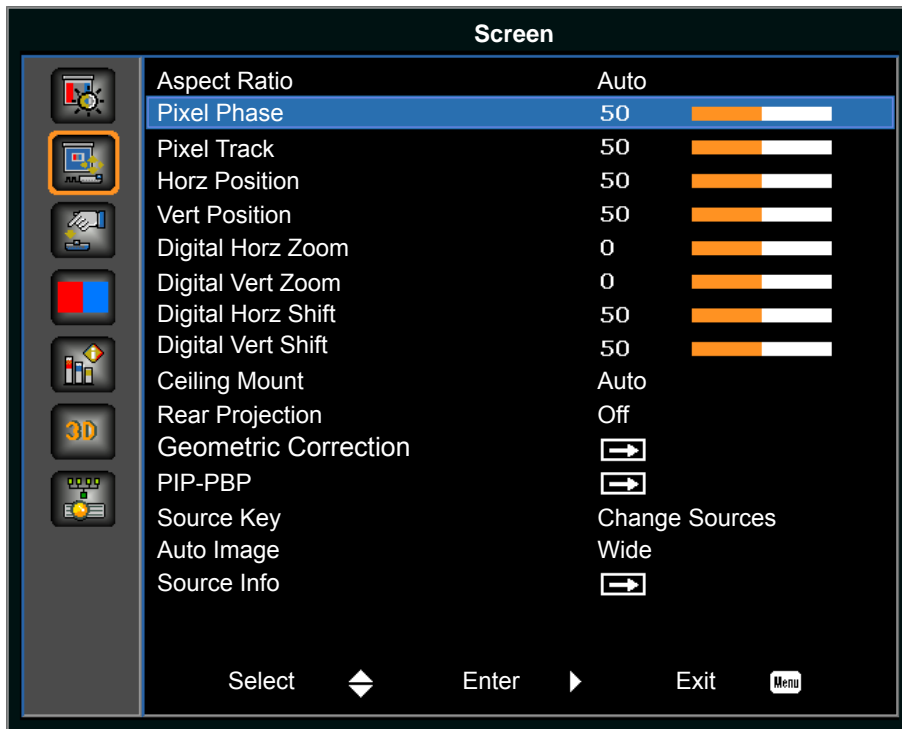

Aspect Ratio

Display an image with the detected size, or resize the image by maximizing either the height, width, both, or resize to the maximum size possible while keeping the original aspect ratio.

- **Auto:** Display with the detected size.
- **4:3:** Retain 4:3 aspect ratio.
- **16:9:** Retain 16:9 aspect ratio.
- **16:10:** Retain 16:10 aspect ratio.
- **Native:** This format displays the original image without any scaling.

Pixel Phase

Adjust the pixel phase when the image shows shimmer or noise after pixel tracking is optimized. Pixel phase can adjust the phase of the pixel-sampling clock relative to the incoming signal. (Analog RGB signals only.)

Pixel Track

Ensure that the image quality is consistent across the screen, the aspect ratio is maintained, and the pixel phase can be optimized. Steady flickering or several soft vertical stripes or bands across the entire image indicates poor pixel tracking. (Analog RGB signals only).

Horz Position

Move the image right or left within the area of available pixels.

Vert Position

Move the image up or down within the area of available pixels.

Digital Horz Zoom

Change the size of projector's display area horizontally. If the display area has been resized by this setting, it can be moved by changing the Digital Horz Shift.

USING THE PROJECTOR

Digital Vert Zoom

Change the size of projector's display area vertically. If the display area has been resized by this setting, it can be moved by changing the Digital Vert Shift settings.

Digital Horz Shift

Move the display area horizontally if its size has been changed by the Digital Horz Zoom setting.

Digital Vert Shift

Move the display area vertically if its size has been changed by the Digital Vert Zoom setting.

Ceiling Mount

Turn the image upside down for ceiling-mounted projection.

Rear Projection

Reverse the image so that you can project from behind a translucent screen.

Geometric Correction

Provide several ways for warping control.

For more information on geometry correction, refer to page 35.

- **H. Keystone:** Adjust the keystone horizontally and make a more square image.
- **V. Keystone:** Adjust the keystone vertically and make a more square image.
- **4-Corner:** Allow the image to be squeezed to fit an area defined by moving each of the four corners' x and y position.
- **Grid Color:** Choose the color of 4 corner, green or purple.
- **Reset:** Restore the settings to its default value.

PIP-PBP

Display an image with two sources in PIP mode or PBP mode.

For more information on PIP/PBP, refer to page 36.

Source Key

List or change the sources. The available options include Change Sources, List all Sources, and Auto Source.

Auto Image

Force the projector to reacquire and lock to the input signal. This is useful when signal quality is marginal.

- **Normal:** Supports all of the 4:3 input sources.
 - **Wide:** Supports all of the 16:9 input source and most of the 4:3 input sources.
- Note:** For the 4:3 input sources not recognized by Wide mode (for example, 1400x1050), perform Auto Image using Normal mode.

Source Info

Display the current source settings. (Read-only).

Geometric Correction menu

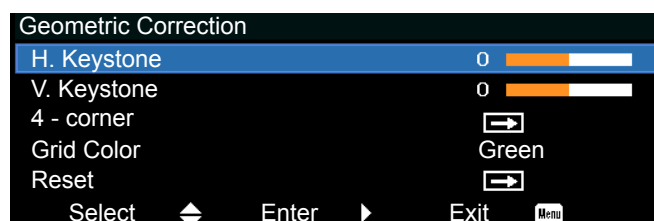

USING THE PROJECTOR

H. Keystone

Adjust image distortion horizontally and make a squarer image. Horizontal keystone is used to correct a keystone image shape in which the left and right borders of the image are unequal in length. This is intended for use with horizontally on-axis applications.

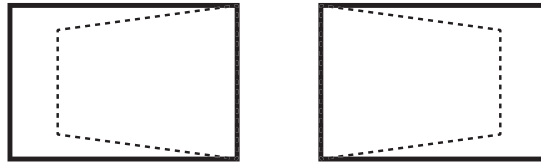

V. Keystone

Adjust image distortion vertically and make a squarer image. Vertical keystone is used to correct a keystone image shape in which the top and bottom are slanted to one of the sides. This is intended when for use with vertically on-axis applications.

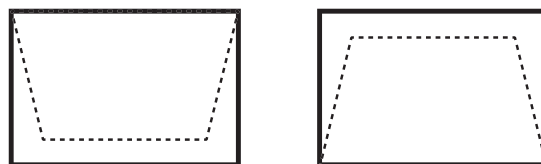

4-Corner

Allow the image to be squeezed to fit an area defined by moving each of the four corners' x and y position.

- **Top Left Horz Adjust (B) / Top Left Vert Adjust (A):** Top left corner can move in to squeeze the image by maximum 120 pixels horizontally and 80 pixels vertically.
- **Top Right Horz Adjust (C) / Top Right Vert Adjust (D):** Top right corner can move in to squeeze the image by maximum 120 pixels horizontally and 80 pixels vertically.
- **Bottom Left Horz Adjust (G) / Bottom Left Vert Adjust (H):** Bottom left corner can move in to squeeze the image by maximum 120 pixels horizontally and 80 pixels vertically.
- **Bottom Right Horz Adjust (F) / Bottom Right Vert Adjust (E):** Bottom right corner can move in to squeeze the image by maximum 120 pixels horizontally and 80 pixels vertically.

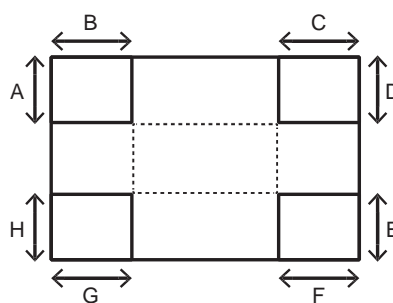

PIP/PBP menu

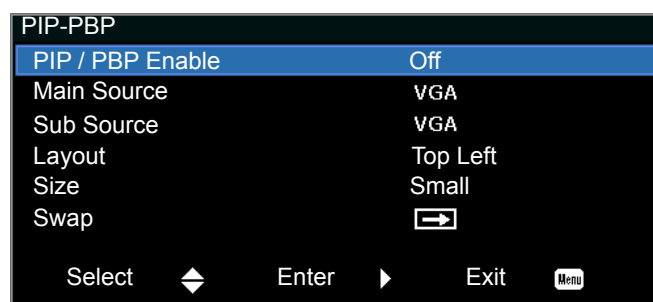

USING THE PROJECTOR

PIP / PBP Enable

Toggle between displaying two sources at once (Main and PIP/PBP images) or one source only.

- **Off:** Display image from the main source only.
- **PBP:** Display images from two sources by separating the screen into two parts. One source is displayed on the main screen and another source is displayed in an inset window.
- **PIP:** Display images from two sources by separating the screen into half. One source is displayed on the left side of the screen and the other source on the right side of the screen. For layout, refer to page 38.

Main Source

Select an active input to be used as the main image. The available inputs include VGA, HDMI-1, HDMI-2, DVI, and HDBaseT.

Sub Source

Select an active input to be used as the sub image. The available inputs include VGA, HDMI-1, HDMI-2, DVI, and HDBaseT.

Layout

Set the location of the PIP/PBP image on the screen. Refer to page 38.

Size

Select the PIP/PBP size to small, medium, or large.

Swap

Change the main image to PIP/PBP, and the PIP/PBP to main image.

Note: *Swapping is available only when PIP/PBP is enabled.*

PIP/PBP Matrix

PIP/PBP compatibility table as described below:

PIP/PBP Matrix	VGA	DVI-D	HDMI-2	HDMI-1	HDBaseT
VGA	—	V	V	V	V
DVI-D	V	—	V	—	—
HDMI-2	V	V	—	V	V
HDMI-1	V	—	V	—	—
HDBaseT	V	—	V	—	—













Note:



1. *Flashing lines may occur if the bandwidth of both inputs are too high, please try to reduce the resolution.*
2. *Frame tearing may occur due to a difference in frame rate between the Main and the Sub picture, please try to match the frame rate for each input.*

USING THE PROJECTOR

Layout and Size

A P indicates the primary source region (lighter color):

PIP Layout	PIP Size		
	Small	Medium	Large
PIP-Bottom Right			
PIP-Bottom Left			
PIP-Top Left			
PIP-Top Right			

PBP Layout	PBP Size		
	Small	Medium	Large
PBP, Main Left	-	-	
PBP, Main Right	-	-	

USING THE PROJECTOR

Settings menu

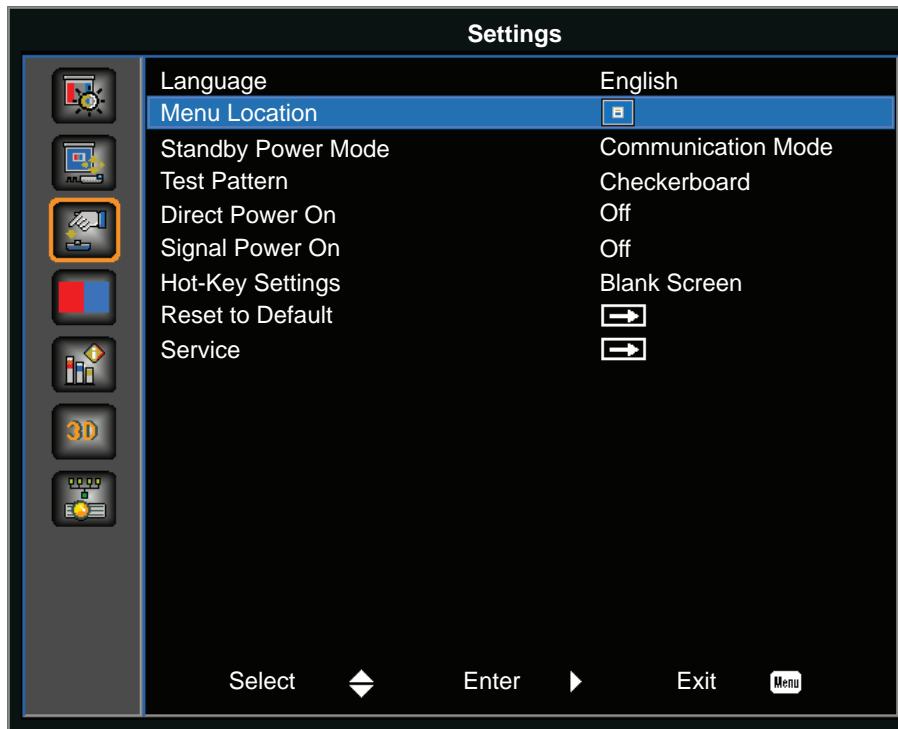

Language

Select an available language for the on-screen display. The available options include English, Simplified Chinese, French, German, Italian, Japanese, Korean, Russian, Spanish, Portuguese, Indonesian, and Dutch.



Menu Location

Set up the on-screen display menu location. The available options include Left Top, Right Top, Center, Left Bottom, and Right Bottom.



Standby Power Mode

Set the standby power mode setting.

- **0.5W mode:** The projector is in standby mode when connected to AC power. (<0.5W).
- **Communication mode:** The projector can be controlled via the LAN terminal during power standby.

USING THE PROJECTOR

Test Pattern

Choose the required internal test pattern to display. The available options include None, Grid, White, Black, Checkerboard, and Color Bars.

Direct Power On

Automatically turn the projector on when electrical power is connected. The available options include On and Off.

Signal Power On

Choose On to activate Signal Power On. The projector will automatically turn on after detecting HDMI input source. The available options include On and Off.

Hot-Key Settings

Assign a different function to the hot key on the IR remote keypad by highlighting the function in the list and pressing **Enter**. Choose a function that does not already have a dedicated button, and assign the hot key to that function, allowing you to quickly and easily use the chosen function. The available options include Blank Screen, Aspect Ratio, Freeze Screen, and Projector Info.

Reset to Default

Restore all settings to their default value. It does not reset network but it resets RS232.

Light source menu

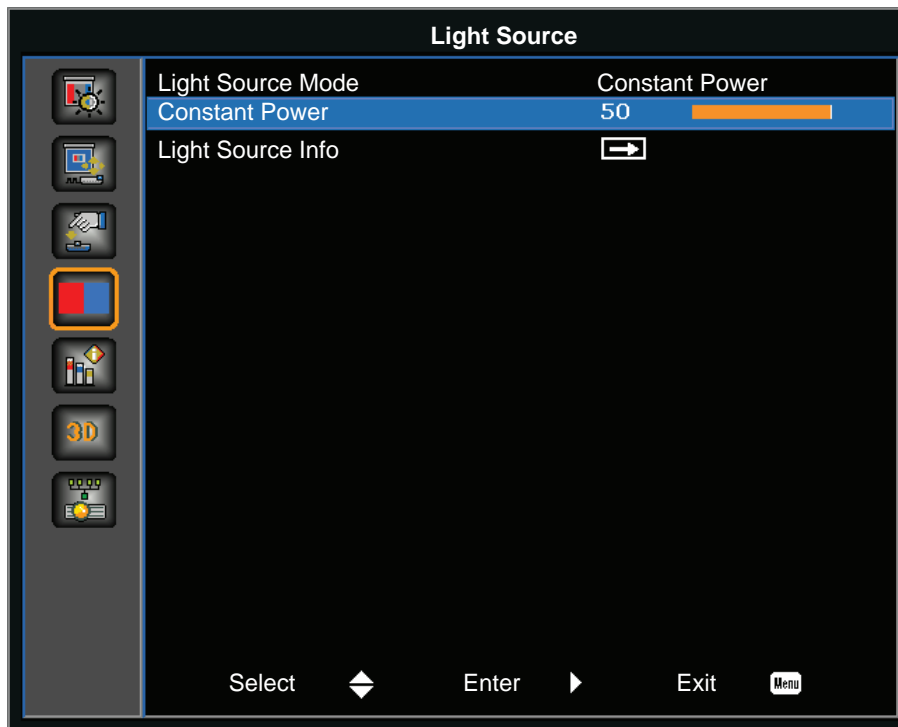

Light Source Mode

Set the light source mode. The available options include Constant Power, Constant Intensity, ECO 1, and ECO 2.

Constant Power

Set the value of the laser diode power.

Light Source Info

Display the total hours of the projector, the total hours of the laser diode that have been used and information on light sensor calibration.

USING THE PROJECTOR

Options menu

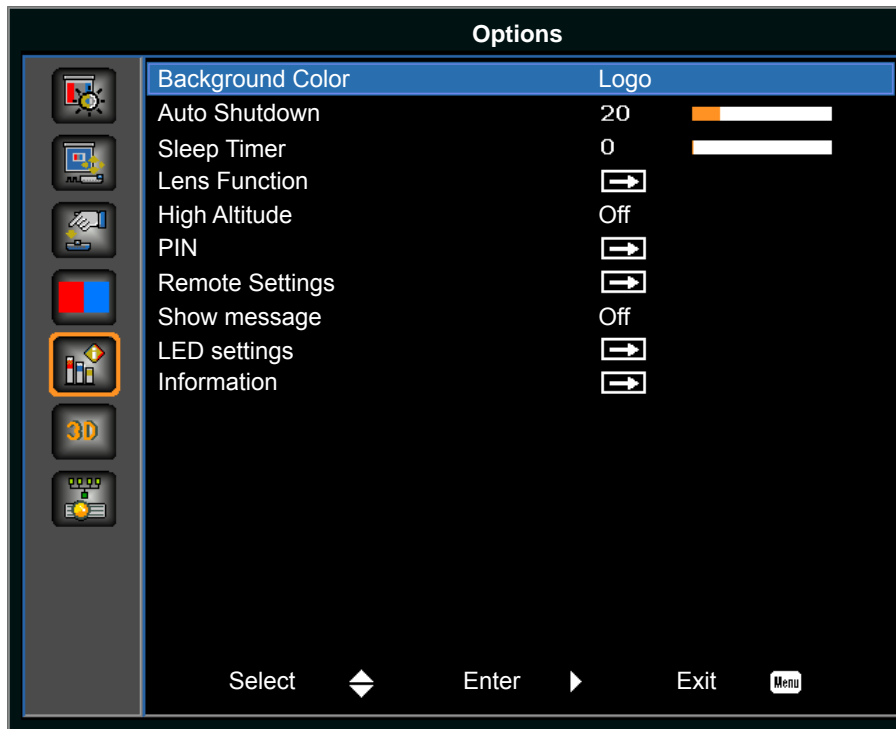

Background Color

Use this feature to display a Logo, Blue, Black, or White screen when no signal is available.

Auto Shutdown

Automatically turn the projector off after no signals are detected for a preset number of minutes. If an active signal is received before the projector powers down, the image is displayed.

Sleep Timer

Allow the projector to automatically power off after it has been on for a specified amount of time.

USING THE PROJECTOR

Lens Function

Adjust the lens parameters.

- **Focus:** Adjust the focus point of the image.
- **Zoom:** Adjust the zoom of the image in or out.
- **Lens Shift:** Shift the lens up and down, or left and right.
- **Lens Memory:** Save the current lens position after doing lens shift. Apply lens position to the chosen set of lens memory. The lens memory can save up to five locations.
- **Lock Lens Motors:** Select this function to prevent all lens motors from moving. It will disable the Zoom, Focus, Horizontal, and Vertical Position settings, effectively locking out any changes and overriding all other lens features. This is particularly useful to prevent accidental lens position changes in multi-projector installations.
- **Lens Calibration:** Calibrate to move the lens back to center.

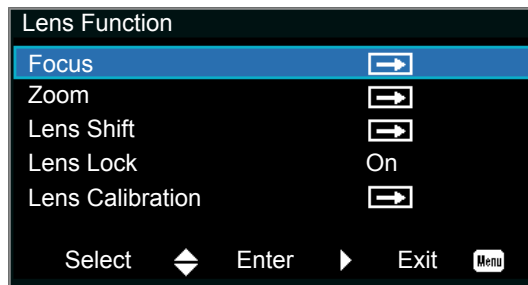

High Altitude

Enable or disable high altitude mode.

- **On:** Enable high altitude mode for altitudes $\geq 2000\text{m}$. The fan operates at high speed to ensure sufficient air flow for high altitudes.
- **Off:** Disable high altitude mode. For altitudes below 2000m.

PIN

Protects your projector with a PIN code. Once enabled, you must enter the PIN code before you can project an image.

- **PIN Protect:** Set to On to enable the function.
- **Change PIN:** Set a new PIN code.

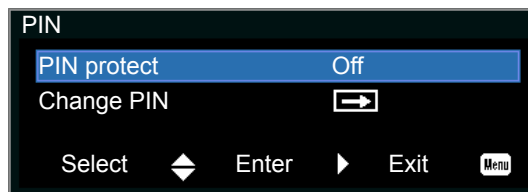

Remote Settings

Turn on or off remote settings, such as Top, Front, HDBaseT, and Projector Address.

Show Message

Hide or display projector settings.

LED Settings

Control the keypad LED and status LED.

Information

Display the projector settings. (Read-only).

USING THE PROJECTOR

3D menu

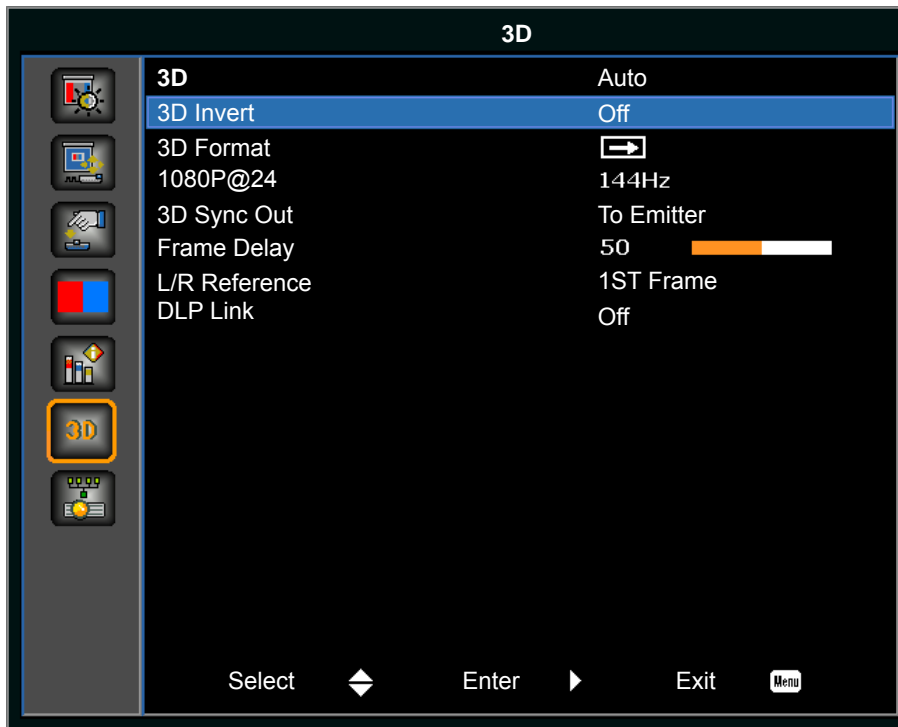

3D

Enable 3D content detection.

3D Invert

Invert the 3D sync signal when using a single projector.

3D Format

Set the 3D format. Supports mandatory 3D formats and frame sequential 3D@120Hz. The available options include Frame Packing, Side-by-Side (Half), Top and Bottom, and Frame Sequential.

1080p@24

Set the 3D resolution 1080p@24 sequency. The available options include 96Hz and 144Hz.

3D Sync Out

Transmit a 3D sync signal by the 3D sync output corrector to the emitter or to the next projector for 3D blending purposes.

Frame Delay

Correct asynchronous displaying of images under 3D blending.

L/R Reference

Source of the left or right reference.

- **1ST Frame:** This is used for single 3D projector.
- **Field GPIO:** Select Field GPIO to make the first 3D output signal the same for multiprojectors application.

DLP Link

Select to use optimized settings for DLP 3D Glasses.

USING THE PROJECTOR

Communications menu

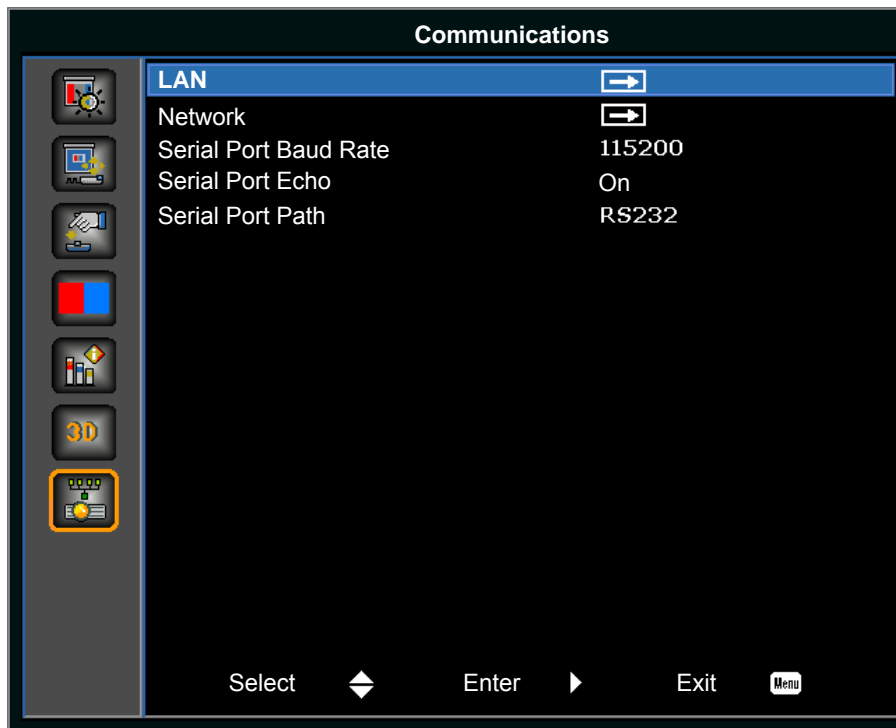

LAN

Determine the communication settings.

- **DHCP:** Turn the DHCP on or off.
- **IP Address:** Assign the network IP address.
- **Subnet Mask:** Assign the network subnet mask.
- **Default Gateway:** Assign the network default gateway.
- **MAC Address:** Display the network MAC address value.
- **Apply:** Apply the LAN configuration when the setting is changed or added.

Network

Determine the network settings.

- **Projector Name:** Display the projector name.
- **Show Network Messages:** Turn network messages on or off.
- **Restart Network...:** Restart the network.
- **Network Factory Reset...:** Performs factory reset on the network settings. The Projector Name, IP Address (LAN), Start IP and End IP, and SNMP settings can be reset.

Serial Port Baud Rate

Select the serial port and baud rate. The available options include 1200, 2400, 4800, 9600, 14400, 19200, 38400, 57600, and 115200.

Serial Port Echo

Control whether the serial port echoes characters.

Serial Port Path

Sets the serial port path to RS232 or HDBaseT.

USING THE PROJECTOR

How to use web browser to control your projector

1. Turn “On” the DHCP option on projector to allow a DHCP server to automatically assign an IP address.
2. Open the web browser in your PC and type in the projector’s IP address (“SETUP: Communications > LAN > IP Address”).

Note: The steps in this section is based on Windows 7 operating system.

Making a direct connection from your computer to the projector* (For Windows 7 or higher)

1. Turn “Off” the DHCP option on the projector.
2. Configure the IP address, Subnet Mask, and Gateway on projector. Refer to page 44.
3. Open **Network and Sharing Center** page on your PC, and assign the identical network parameters to your PC as set on projector. Click “OK” to save the parameters.

Note: The last group (ex: 100) of the IP address should be different from the projector. Make sure the network parameters (i.e. other groups of the IP address and the Subnet mask) are similar to those shown in the OSD menu.

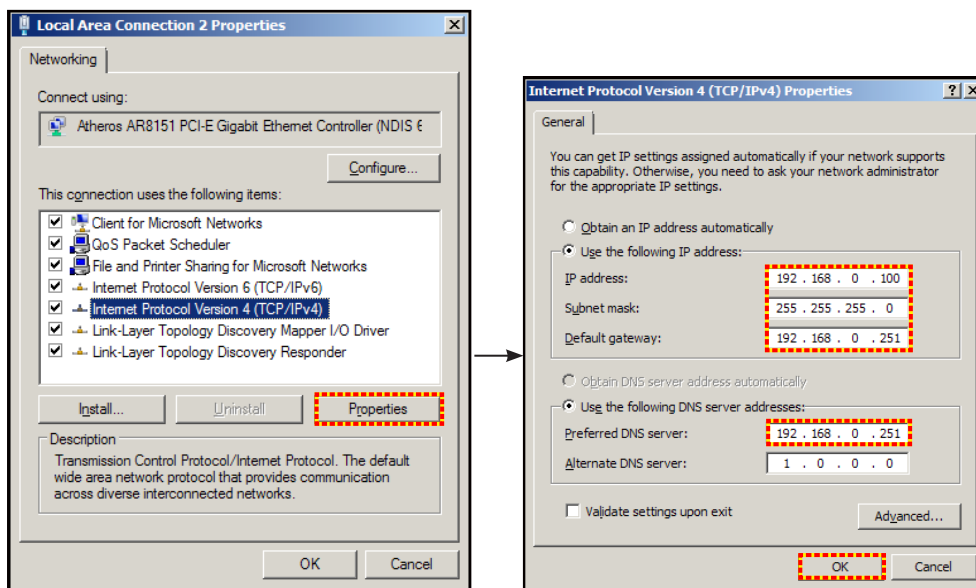

4. Open the web browser on your computer and type the projector IP address into the URL field, then press “Enter”.

USING THE PROJECTOR

Setup network control settings menu

LAN RJ45 function

For simplicity and ease of operation, the projector provides diverse networking and remote management features. The LAN / RJ45 function of the projector through a network, such as remotely manage: Power On / Off, Brightness and Contrast settings. Also you can view the projector status information, such as: Video- Source, etc.

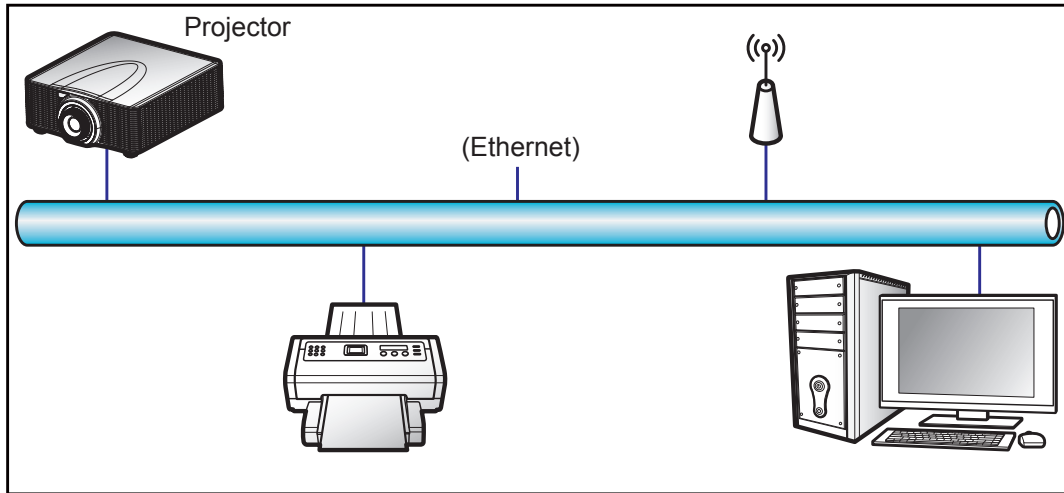

Wired LAN terminal functionalities

This projector can be controlled by using a PC (laptop) or other external device via RJ-45 connector and compatible with Crestron / Extron / AMX (Device Discovery) / PJLink.

- Crestron is a registered trademark of Crestron Electronics, Inc. of the United States.
- Extron is a registered trademark of Extron Electronics, Inc. of the United States.
- AMX is a registered trademark of AMX LLC of the United States.
- PJLink applied for trademark and logo registration in Japan, the United States of America, and other countries by JBMIA.

The projector is supported by the specified commands of the Crestron Electronics controller and related software, for example RoomView®.

<http://www.crestron.com/>

This projector is compliant to support Extron device(s) for reference.

<http://www.extron.com/>

This projector is supported by AMX (Device Discovery).

<http://www.amx.com/>

This projector supports all commands of PJLink Class1 (Version 1.00).

<http://pjlink.jbmia.or.jp/english/>

For more detailed information about the various types of external devices which can be connected to the LAN / RJ45 port and remote control the projector, as well as the supported commands for these external devices, please contact the Support-Service directly.

USING THE PROJECTOR

LAN RJ45 (For Windows XP)

1. Connect an RJ45 cable to RJ-45 connector on the projector and the PC (laptop).

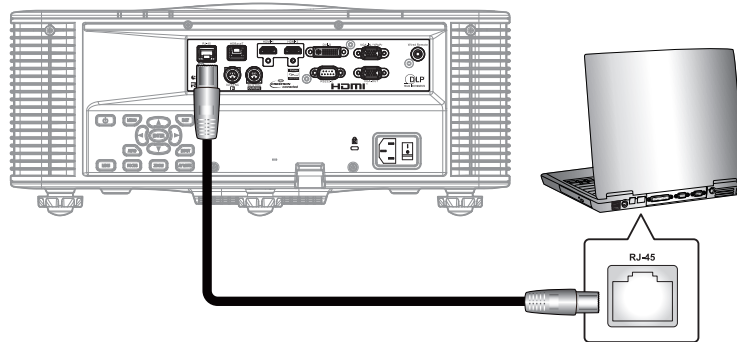

2. On the PC (Laptop), select **Start > Control Panel > Network Connections**.

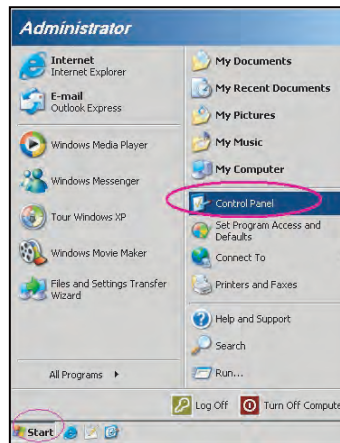

3. Right-click on the **Local Area Connection**, and select **Property**.

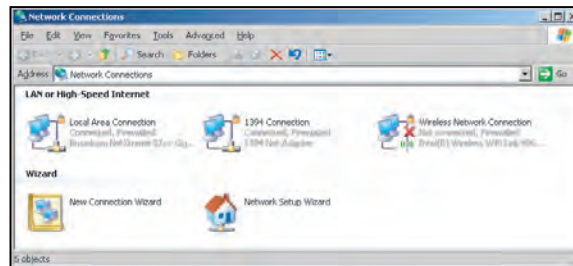

4. In the **Properties** window, select the **General tab**, and select **Internet Protocol (TCP / IP)**.

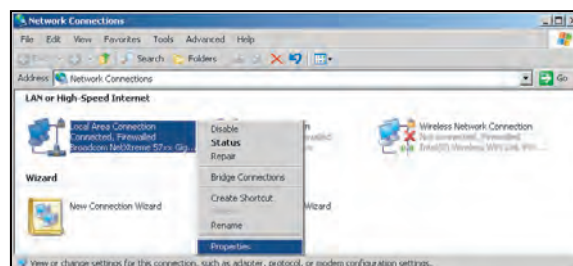

USING THE PROJECTOR

5. Click “Properties”.

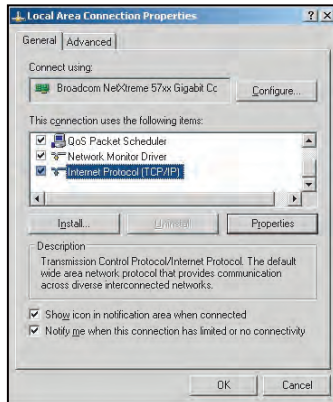

6. Type in the IP address and Subnet mask, then press “OK”.

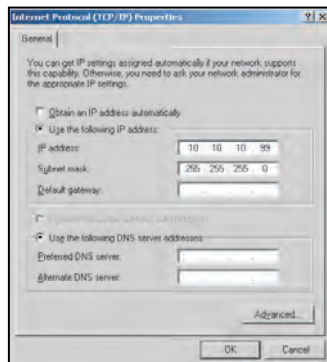

7. Press the “Menu” button on the projector.
8. Select **Communications > LAN**.
9. Enter the following connection parameters:
 - DHCP: Off
 - IP Address: 10.10.10.10
 - Subnet Mask: 255.255.255.0
 - Default Gateway: 0.0.0.0
10. Press “Enter” to confirm settings.
11. Open a web browser, for example Microsoft Internet Explorer with Adobe Flash Player 9.0 or higher installed.
12. In the Address bar, input the projector’s IP address: 10.10.10.10.

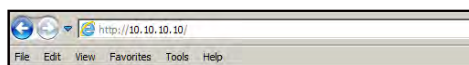

13. Press “Enter”.

USING THE PROJECTOR

The projector is setup for remote management. The LAN / RJ45 function displays as follows:

Main page

Main
Network Setting
Configurations
Information

Control

Power ON OFF

Main Source

Sub Source

PIP/PBP

AV Mute ON OFF

Freeze ON OFF

Key

Menu	Up	Exit
Left	Enter	Right
	Down	Input

Network Setting page

Main
Network Setting
Configurations
Information

Control

Projector Name

Network Restart

Network Factory Reset

LAN Settings

DHCP ON OFF

IP Address

Subnet Mask

Default Gateway

MAC Address

Crestron Control System

Control System IP

IPID

Port

Configurations page

Main
Network Setting
Configurations
Information

Image Settings

Color

Brightness

Sharpness

Contrast

Configurations

Display mode

Ceiling Mount

Standby Mode

Light Source Settings

Light Source Mode

Constant Power

Test Pattern

Test Pattern

Information page

Main
Network Setting
Configurations
Information

FW Version	
Scaler	
MCU	A00.27
LAN	A02.25
Other	
Model Name	DAZULUU
Serial Number	
Light Source Hours	0

USING THE PROJECTOR

RS232 by Telnet Function

There is alternative RS232 command control way, in projector so called “RS232 by TELNET” for LAN / RJ45 interface.

Quick Start-Guide for “RS232 by Telnet”

- Check and get the IP address on OSD of the projector.
- Make sure that the PC / laptop can access the web-page of the projector.
- Make sure that “Windows Firewall” setting is set disabled in case of “TELNET” function filtering out by PC / laptop.

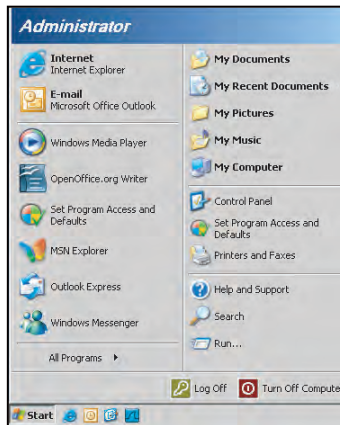

1. Select **Start > All Programs > Accessories > Command Prompt**.

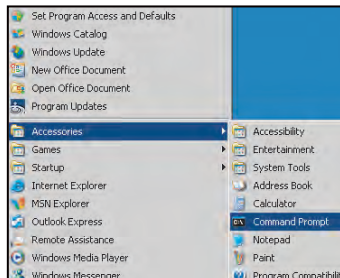

2. Input the command format as follows:
 - telnet ttt.xxx.yyy.zzz 3023 (“Enter” key pressed)
 - (ttt.xxx.yyy.zzz: IP-Address of the projector)
3. If Telnet-Connection ready, and user can have RS232 command input, then “Enter” key pressed, the RS232 command will be workable.

Specification for “RS232 by TELNET”:

1. Telnet: TCP.
2. Telnet port: 3023 (for more detail, kindly please get contact with the service agent or team).
3. Telnet utility: Windows “TELNET.exe” (console mode).
4. Disconnection for RS232-by-Telnet control normally: Close
5. Windows Telnet utility directly after TELNET connection ready.
 - Limitation 1 for Telnet-Control: there is less than 50 bytes for successive network payload for Telnet-Control application.
 - Limitation 2 for Telnet-Control: there is less than 26 bytes for one complete RS232 command for Telnet-Control.
 - Limitation 3 for Telnet-Control: Minimum delay for next RS232 command must be more than 200 (ms).

ADDITIONAL INFORMATION

Compatible resolutions

Timing Table

Signal Type	Resolution	Frame rate (Hz)	VGA	HDMI-1/ HDMI-2	DVI	HDBaseT
PC	640x350	85	V	V	V	V
	640x400	85	V	V	V	V
	640x480	59	V	V	V	V
	640x480	60	V	V	V	V
	640x480	72	V	V	V	V
	640x480	75	V	V	V	V
	640x480	85	V	V	V	V
	720x400	60	V	V	V	V
	720x400	85	V	V	V	V
	768x480	60	V	V	V	V
	768x480	75	V	V	V	V
	768x480	85	V	V	V	V
	800x600	50	V	V	V	V
	800x600	56	V	V	V	V
	800x600	60	V	V	V	V
	800x600	72	V	V	V	V
	800x600	75	V	V	V	V
	800x600	85	V	V	V	V
	800x600	120	V	V	V	V
	848x480	50	V	V	V	V
	848x480	60	V	V	V	V
	848x480	75	V	V	V	V
	848x480	85	V	V	V	V
	960x600	50	V	V	V	V
	960x600	60	V	V	V	V
	960x600	75	V	V	V	V
	960x600	85	V	V	V	V
	1024x768	60	V	V	V	V
	1024x768	75	V	V	V	V
	1024x768	85	V	V	V	V
	1024x768	120	V	V	V	V
	1064x600	50	V	V	V	V
	1064x600	60	V	V	V	V
	1064x600	75	V	V	V	V
	1064x600	85	V	V	V	V
	1152x720	50	V	V	V	V
	1152x720	60	V	V	V	V
	1152x720	75	V	V	V	V
	1152x720	85	V	V	V	V
	1152x864	60	V	V	V	V
1152x864	70	V	V	V	V	
1152x864	75	V	V	V	V	
1152x864	85	V	V	V	V	
1224x768	50	V	V	V	V	
1224x768	60	V	V	V	V	

ADDITIONAL INFORMATION

Signal Type	Resolution	Frame rate (Hz)	VGA	HDMI-1/ HDMI-2	DVI	HDBaseT
PC	1224x768	85	V	V	V	V
	1280x720	50	V	V	V	V
	1280x720	60	V	V	V	V
	1280x720	75	V	V	V	V
	1280x720	85	V	V	V	V
	1280x720	120	V	V	V	V
	1280x768	60	V	V	V	V
	1280x768	75	V	V	V	V
	1280x768	85	V	V	V	V
	1280x800	50	V	V	V	V
	1280x800	60	V	V	V	V
	1280x800	75	V	V	V	V
	1280x800	85	V	V	V	V
	1280x960	50	V	V	V	V
	1280x960	60	V	V	V	V
	1280x960	75	V	V	V	V
	1280x960	85	V	V	V	V
	1280x1024	50	V	V	V	V
	1280x1024	60	V	V	V	V
	1280x1024	75	V	V	V	V
	1280x1024	85	V	V	V	V
	1356x960	50	—	—	V	—
	1356x960	60	—	—	V	—
	1356x960	75	—	—	V	—
	1356x960	85	—	—	V	—
	1360x768	50	V	V	V	V
	1360x768	60	V	V	V	V
	1360x768	75	V	V	V	V
	1360x768	85	V	V	V	V
	1366x768	60	V	V	V	V
	1400x900	60	V		V	
	1400x1050	50	V	V	V	V
	1400x1050	60	V	V	V	V
	1400x1050	75	V	V	V	V
	1440x900	60	V	V	V	V
	1440x900	75	V	V	V	V
	1600x900	60	V	V	V	V
	1600x1200	50	V	V	V	V
	1600x1200	60	V	V	V	V
	1680x1050	50	V	V	V	V
	1680x1050	60	V	V	V	V
	1680x1050	75	V	—	—	—
	1704x960	50	V	V	V	V
	1704x960	60	V	V	V	V
	1704x960	75	V	—	—	—
1704x960	85	V	—	—	—	
1728x1080	50	V	V	V	V	
1728x1080	60	V	V	V	V	

ADDITIONAL INFORMATION

Signal Type	Resolution	Frame rate (Hz)	VGA	HDMI-1/ HDMI-2	DVI	HDBaseT
PC	1864x1050	50	V	V	V	V
	1864x1050	60	V	V	V	V
	1864x1050	75	V	—	—	—
	1920X1080	50	V	V	V	V
	1920X1080	60	V	V	V	V
	1920X1200RB	60	V	V	V	V
	1920X1200RB	50	V	V	V	V
	2128x1200	60	V	—	—	—
SDTV	480i	60	V	V	V	V
	576i	50	V	—	—	—
EDTV	480p	60	V	V	V	V
	576p	50	V	V	V	V
HDTV	1080i	25	V	V	V	V
	1080i	29	V	V	V	V
	1080i	30	V	V	V	V
	720p	50	V	V	V	V
	720p	59	V	V	V	V
	720p	60	V	V	V	V
	1080s	23	—	—	V	—
	1080s	24	—	—	V	—
	1080p	23	V	V	V	V
	1080p	24	V	V	V	V
	1080p	25	V	V	V	V
	1080p	29	V	V	V	V
	1080p	30	V	V	V	V
	1080p	50	V	V	V	V
	1080p	59	V	V	V	V
	1080p	60	V	V	V	V
Mandatory 3D	Frame Packing 1080p	24	—	V	V	V
	Frame Packing 720p	50	—	V	V	V
	Frame Packing 720p	60	—	V	V	V
	Side by Side 1080i	50	—	V	V	V
	Side by Side 1080i	60	—	V	V	V
	Top and Bottom 720p	50	—	V	V	V
	Top and Bottom 720p	60	—	V	V	V
	Top and Bottom 1080p	24	—	V	V	V
Frame sequential 3D	1024x768	120	—	V	V	V
	1280x720	120	V	V	V	V

Note: “RB” means “reduced blanking”.

ADDITIONAL INFORMATION

EDID Table

WUXGA / VGA		
Established Timing:	Standard Timing:	Detail Timing:
720x400 @ 88 Hz	1440x900 @ 75 Hz	1366x768 @ 60 Hz
640x480 @ 60 Hz	1280x800 @ 75 Hz	1920x540 @ 60 Hz
640x480 @ 67 Hz	1280x1024 @ 60 Hz	1920x540 @ 50 Hz
640x480 @ 72 Hz	1360x765 @ 60 Hz	720x480 @ 60 Hz
640x480 @ 75 Hz	1440x900 @ 60 Hz	1360x768 @ 60 Hz
800x600 @ 56 Hz	1400x1050 @ 60 Hz	
800x600 @ 60 Hz	1600x1200 @ 60 Hz	
800x600 @ 72 Hz	1680x1050 @ 60 Hz	
800x600 @ 75 Hz		
832x624 @ 75 Hz		
1024x768 @ 60 Hz		
1024x768 @ 70 Hz		
1024x768 @ 75 Hz		
1280x1024 @ 75 Hz		
1152x870 @ 75 Hz		

WUXGA / DVI-D		
Established Timing:	Standard Timing:	Detail Timing:
720x400 @ 70 Hz	1024x768 @ 120 Hz	1360x768 @ 60 Hz
720x400 @ 88 Hz	1280x800 @ 75 Hz	1366x768 @ 60 Hz
640x480 @ 60 Hz	1280x1024 @ 60 Hz	1920x540 @ 60 Hz
640x480 @ 67 Hz	1360x765 @ 60 Hz	720x480 @ 60 Hz
640x480 @ 72 Hz		
640x480 @ 75 Hz	1400x1050 @ 60 Hz	
800x600 @ 56 Hz	1600x1200 @ 60 Hz	
800x600 @ 60 Hz	1680x1050 @ 60 Hz	
800x600 @ 72 Hz		
800x600 @ 75 Hz		
832x624 @ 75 Hz		
1024x768 @ 60 Hz		
1024x768 @ 70 Hz		
1024x768 @ 75 Hz		
1280x1024 @ 75 Hz		
1152x870 @ 75 Hz		

ADDITIONAL INFORMATION

WUXGA / HDMI & HDBaseT		
Established Timing:	Standard Timing:	Detail Timing:
720x400 @ 70 Hz	1024x768 @ 120 Hz	720x576 @ 50 Hz
720x400 @ 88 Hz	1280x800 @ 75 Hz	1280x720 @ 60 Hz
640x480 @ 60 Hz	1280x1024 @ 60 Hz	1920x540 @ 60 Hz
640x480 @ 67 Hz	1280x720 @ 120 Hz	720x480 @ 60 Hz
640x480 @ 72 Hz		
640x480 @ 75 Hz	1400x1050 @ 60 Hz	
800x600 @ 56 Hz	1600x1200 @ 60 Hz	
800x600 @ 60 Hz	1680x1050 @ 60 Hz	
800x600 @ 72 Hz		
800x600 @ 75 Hz		
832x624 @ 75 Hz		
1024x768 @ 60 Hz		
1024x768 @ 70 Hz		
1024x768 @ 75 Hz		
1280x1024 @ 75 Hz		
1152x870 @ 75 Hz		

ADDITIONAL INFORMATION

Image size and projection distance

Platform			WUXGA (16:10)										
DMD			0.67"										
Projection Lens			A16	A01		A02		A03		A13		A15	
Throw Ratio			0.361 (120")	0.95-1.22		1.22-1.53		1.52-2.92		2.90-5.50		0.75-0.95	
Zoom Ratio			N/A	1.28X		1.25X		1.9X		1.9X		1.26X	
Throw Distance			0.96- 3.01m	1.01-13.33m		1.30-16.62m		1.61-31.70m		3.18-57.86m		0.79-10.38m	
Projection screen size			Projection distance (m)										
Throw Ratio			0.361 (120")	0.95	1.22	1.22	1.53	1.52	2.92	2.90	5.50	0.75	0.95
Diagonal (inch)	Height (m)	Width (m)	(m)	Min (m)	Max (m)	Min (m)	Max (m)	Min (m)	Max (m)	Min (m)	Max (m)	Min (m)	Max (m)
50	0.67	1.08	-	1.01	1.31	1.30	1.63	1.61	3.12	3.18	5.89	0.79	1.01
60	0.81	1.29	-	1.22	1.57	1.57	1.97	1.94	3.76	3.78	7.05	0.96	1.22
70	0.94	1.51	-	1.43	1.84	1.83	2.30	2.27	4.39	4.39	8.20	1.12	1.43
80	1.08	1.72	-	1.63	2.11	2.10	2.63	2.60	5.03	5.00	9.36	1.28	1.64
90	1.21	1.94	-	1.84	2.38	2.36	2.97	2.94	5.66	5.61	10.51	1.45	1.85
100	1.35	2.15	-	2.05	2.64	2.63	3.30	3.27	6.30	6.21	11.67	1.61	2.05
110	1.48	2.37	-	2.26	2.91	2.90	3.63	3.60	6.93	6.82	12.82	1.78	2.26
120	1.62	2.58	0.96	2.47	3.18	3.16	3.97	3.94	7.57	7.43	13.98	1.94	2.47
130	1.75	2.80	1.04	2.67	3.44	3.43	4.30	4.27	8.20	8.04	15.13	2.10	2.68
140	1.88	3.02	1.11	2.88	3.71	3.69	4.63	4.60	8.84	8.65	16.29	2.27	2.89
150	2.02	3.23	1.18	3.09	3.98	3.96	4.96	4.94	9.47	9.25	17.44	2.43	3.09
160	2.15	3.45	1.26	3.30	4.24	4.23	5.30	5.27	10.11	9.86	18.60	2.60	3.30
170	2.29	3.66	1.33	3.51	4.51	4.49	5.63	5.60	10.74	10.47	19.75	2.76	3.51
180	2.42	3.88	1.40	3.72	4.78	4.76	5.96	5.93	11.38	11.08	20.91	2.92	3.72
190	2.56	4.09	1.48	3.92	5.05	5.02	6.30	6.27	12.01	11.69	22.06	3.09	3.93
200	2.69	4.31	1.55	4.13	5.31	5.29	6.63	6.60	12.65	12.29	23.22	3.25	4.13
250	3.37	5.38	1.91	5.17	6.65	6.62	8.29	8.27	15.82	15.33	28.99	4.07	5.17
300	4.04	6.46	2.28	6.21	7.98	7.95	9.96	9.93	19.00	18.37	34.77	4.89	6.21
350	4.71	7.54	2.65	7.25	9.32	9.28	11.62	11.60	22.17	21.41	40.54	5.71	7.26
400	5.38	8.62	3.01	8.29	10.66	10.61	13.29	13.26	25.35	24.45	46.31	6.53	8.30
450	6.06	9.69	-	9.33	11.99	11.94	14.95	14.93	28.52	27.49	52.09	7.35	9.34
500	6.73	10.77	-	10.37	13.33	13.27	16.62	16.59	31.70	30.53	57.86	8.17	10.38

 projected image
 V projected image height
 H projected image width
 A02/A15

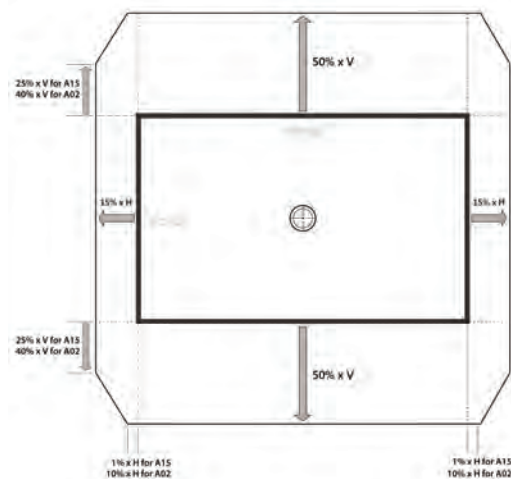

 projected image
 V projected image height
 H projected image width
 A01/A03/A13

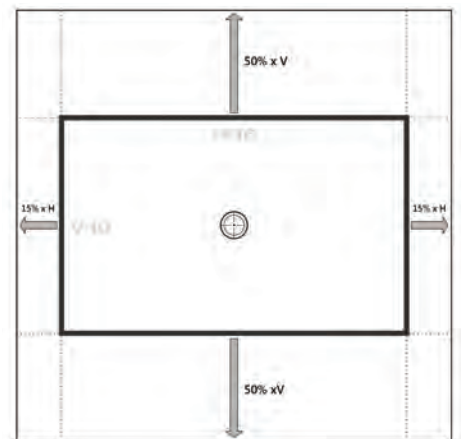

ADDITIONAL INFORMATION

Projector dimensions and ceiling mount installation

1. To prevent damage to your projector, please use the Optoma ceiling mount.
2. If you wish to use a third party ceiling mount kit, please ensure the screws used to attach a mount to the projector meet the following specifications:
 - Screw type: M6 x 4
 - Minimum screw length: 20mm

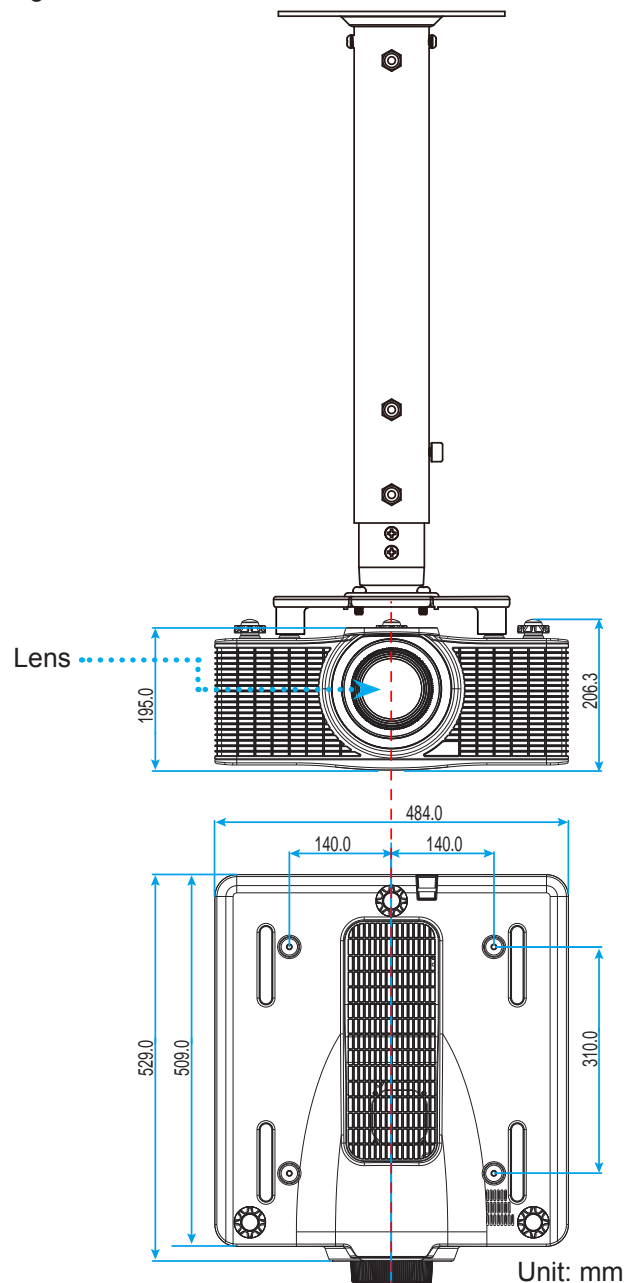

Note: Please note that damage resulting from incorrect installation will void the warranty.



Warning:

- If you buy a ceiling mount from another company, please be sure to use the correct screw size. Screw size will vary depending on the thickness of the mounting plate.
- Be sure to keep at least 30mm (3cm) gap between the ceiling and the bottom of the projector.
- Avoid installing the projector near a heat source.

ADDITIONAL INFORMATION

IR remote codes



Key Legend	Key Position	Repeat Format	Address		Data		Description
			Byte 1	Byte 2	Byte 3	Byte 4	
ON (ON)	1	F1	32	CD	02	FD	Press to turn on the projector.
OFF (OFF)	2	F1	32	CD	2E	D1	Press to turn off the projector.
1	3	F1	32	CD	72	8D	Use as numeric keypad number "1".
2	4	F1	32	CD	73	8C	Use as numeric keypad number "2".
3	5	F1	32	CD	74	8B	Use as numeric keypad number "3".
4	6	F1	32	CD	75	8A	Use as numeric keypad number "4".
5	7	F1	32	CD	77	88	Use as numeric keypad number "5".

ADDITIONAL INFORMATION







Key Legend	Key Position	Repeat Format	Address		Data		Description
			Byte 1	Byte 2	Byte 3	Byte 4	
6	8	F1	32	CD	78	87	Use as numeric keypad number "6".
7	9	F1	32	CD	79	86	Use as numeric keypad number "7".
8	10	F1	32	CD	80	7F	Use as numeric keypad number "8".
9	11	F1	32	CD	81	7E	Use as numeric keypad number "9".
Info	12	F1	32	CD	82	7D	Press to display source image information.
0	13	F1	32	CD	25	DA	Use as numeric keypad number "0".
Mode	14	F1	32	CD	05	FA	Press to select the preset display mode.
Auto	15	F1	32	CD	04	FB	Press to automatically synchronize the projector to the input source.
Input	16	F1	32	CD	18	E7	Press to select an input signal.
UP (▲)	17	F1	32	CD	0F	F0	Press to select items or make adjustments to our selection.
LEFT (◀)	18	F1	32	CD	11	EE	Press to select items or make adjustments to our selection.
Enter	19	F1	32	CD	14	EB	Press to confirm your item selection.
RIGHT (▶)	20	F1	32	CD	10	EF	Press to select items or make adjustments to our selection.
DOWN (▼)	21	F1	32	CD	12	ED	Press to select items or make adjustments to our selection.
Menu	22	F1	32	CD	0E	F1	Press to display the on-screen display menus for projector.
Exit	23	F1	32	CD	2A	D5	Press to return to previous level or exit menus if at top level.
Gamma	24	F1	32	CD	2B	D4	Press to adjust mid-range levels..
Bright	25	F1	32	CD	28	D7	Press to adjust amount of light in the image.
Cont.	26	F1	32	CD	29	D6	Press to adjust difference between dark and light.
PIP	27	F1	32	CD	43	BC	Press to turn on/off the PIP/PBP function.
Lens H◀	28	F1	32	CD	41	BE	Press to adjust the position of the image horizontally.
Lens H▶	29	F1	32	CD	42	BD	
Focus ▲	30	F1	32	CD	86	79	Press to adjust focus to improve image clarity as desired.
Lens V ▲	31	F1	32	CD	34	CB	Press to adjust the position of the image vertically.
Lens V ▼	32	F1	32	CD	32	CD	Press to adjust the position of the image vertically.
Focus ▼	33	F1	32	CD	26	D9	Press to adjust focus to improve image clarity as desired.
Keystone ▽	34	F1	32	CD	87	78	Press to adjust the vertical keystone.
Keystone ▽	35	F1	32	CD	51	AE	Press to adjust the vertical keystone.
Zoom ▲	36	F1	32	CD	52	AD	Press to adjust zoom to achieve a desired image size.
Keystone ◻	37	F1	32	CD	53	AC	Press to adjust the horizontal keystone.
Keystone ◻	38	F1	32	CD	54	AB	Press to adjust the horizontal keystone.
Zoom ▼	39	F1	32	CD	55	AA	Press to adjust zoom to achieve a desired image size.
Shutter (AV Mute)	40	F1	32	CD	56	A9	Press to hide/unhide the screen picture.
Hot Key	41	F1	32	CD	57	A8	Press to select your preset keys quickly.
Pattern	42	F1	32	CD	58	A7	Press to display a test pattern.

ADDITIONAL INFORMATION

Troubleshooting

If you experience a problem with your projector, please refer to the following information. If a problem persists, please contact your local reseller or service center.

Image problems

-  *No image appears on-screen*
- Ensure all the cables and power connections are correctly and securely connected as described in the "Installation" section.
 - Ensure the pins of connectors are not crooked or broken.
 - Ensure that the "Shutter (AV Mute)" feature is not turned on.
-  *Image is out of focus*
- Press the **Focus ▲** or **Focus ▼** button on the remote control to adjust the focus until the image is sharp and legible.
 - Make sure the projection screen is between the required distance from the projector. (Please refer to page 56).
-  *The image is stretched when displaying 16:10 DVD title*
- When you play anamorphic DVD or 16:10 DVD, the projector will show the best image in 16:10 format on projector side.
 - If you play 4:3 format DVD title, please change the format as 4:3 in projector OSD.
 - Please setup the display format as 16:10 (wide) aspect ratio type on your DVD player.
-  *Image is too small or too large*
- Press the **Zoom ▲** or **Zoom ▼** button on the remote control to increase or decrease the projected image size.
 - Move the projector closer to or further from the screen.
 - Press "Menu" on the projector panel, go to "Screen > Aspect Ratio". Try the different settings.
-  *Image has slanted sides:*
- If possible, reposition the projector so that it is centered on the screen and below the bottom of the screen.
 - Use "Screen > Geomteric Correction > V. Keystone or H. Keystone" from the OSD to make an adjustment.
-  *Image is reversed*
- Select "Screen > Rear Projection > On" from the OSD to reverse the image so you can project from behind a translucent screen.

Other problems

-  *The projector stops responding to all controls*
- If possible, turn off the projector, then unplug the power cord and wait at least 20 seconds before reconnecting power.

ADDITIONAL INFORMATION

Remote control problems

-  *If the remote control does not work*
- Check the operating angle of the remote control is pointed within $\pm 30^\circ$ (horizontally or vertically) to the IR receivers on the projector.
 - Make sure there are not any obstructions between the remote control and the projector. Move to within 10 m (32.8 ft) of the projector.
 - Make sure batteries are inserted correctly.
 - Replace batteries if they are exhausted.

Warning indicators

LED status indicators

The LED status indicators are located on the rear of the projector. Each LED is defined below.

Message	Light			Status			AV Mute	
	Green	Orange	Red	Green	Orange	Red	Green	Orange
Standby State				Flashing				
Power on (Warm up)					Flashing			
Power on & Laser diode on	Steady			Steady			Steady	
Power off (Cooling down)					Flashing			
AV mute is off (Image is displayed)	Steady			Steady			Steady	
AV mute is on (Image is black)	Steady			Steady				Steady
Projector communication	Steady			Flashing			Steady	
Firmware upgrade				Flashing	Flashing			
Laser diode time has expired		Steady						
Unit loses over 60% initial luminance			Flashing					
Error (Over temperature)						Steady		
Error (Fan failure)						Flashing		

ADDITIONAL INFORMATION

- Power off:

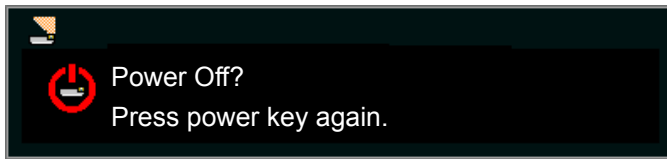

LAN Control Setting:

LAN Control	Port
AMX	9131
Crestron	41794
PJ-Link	4352
Telnet	3023
Http	80

ADDITIONAL INFORMATION

Specifications

Optical	Description
Resolution	Native Resolution: WUXGA (1920x1200) Supported Resolution: Up to WUXGA@60Hz (Reduced Blanking)
Lens	Power Zoom/Focus and full lens shift
Laser Diode	70W@2.3A / Tc 60°
Image size (diagonal)	50~500"
Projection distance	Please refer to "Image size and projection distance" table on page 56.

Electrical	Description
Inputs	2 x HDMI (version1.4) (with locking screw) 1 x DVI-D (only support digital signal) 1 x VGA IN (D-Sub 15pin) (Computer In or Component) 1 x HDBaseT 1 x 3D SYNC IN
Outputs	1 x VGA Out (Support VGA loops through to monitor) (Monitor Out) 1 x 3D SYNC Out
Control port	1 x RS232 (D-sub 9 pin) (PC Control) 1 x Wired In (3.5mm phone jack) (Remote In) 1 x RJ45 (LAN) 2 x IR Receiver (On the Front side and Top side)
Power requirement	AC 100V - 240V, 50/60Hz
Input current	7.0A

Mechanical	Description
Installation orientation	Table Top, Ceiling Mount, Portrait
Dimensions	484 (W) x 509 (D) x 185 (H) mm (without lens, w/o elevators)
Weight	17 kg (without lens)
Environmental conditions	Operating: 5~40°C, 10~85%RH, non-condensing



Note: All specifications are subject to change without notice.

Optoma global offices

For service or support, please contact your local office.



USA

Optoma Technology, Inc.
47697 Westinghouse Drive.
Fremont, Ca 94539

 888-289-6786
 510-897-8601
 services@optoma.com



Canada

Optoma Technology, Inc.
47697 Westinghouse Drive.
Fremont, Ca 94539

 888-289-6786
 510-897-8601
 services@optoma.com



Latin America

Optoma Technology, Inc.
47697 Westinghouse Drive.
Fremont, Ca 94539

 888-289-6786
 510-897-8601
 services@optoma.com



Europe

Unit 1, Network 41, Bourne End Mills
Hemel Hempstead, Herts,
HP1 2UJ, United Kingdom
www.optoma.eu
Service Tel : +44 (0)1923 691865

 +44 (0) 1923 691 800
 +44 (0) 1923 691 888
 service@tsc-europe.com



Benelux BV

Randstad 22-123
1316 BW Almere
The Netherlands
www.optoma.nl

 +31 (0) 36 820 0252
 +31 (0) 36 548 9052



France

Bâtiment E
81-83 avenue Edouard Vaillant
92100 Boulogne Billancourt, France

 +33 1 41 46 12 20
 +33 1 41 46 94 35
 savoptoma@optoma.fr



Spain

C/ José Hierro,36 Of. 1C
28522 Rivas VaciaMadrid,
Spain

 +34 91 499 06 06
 +34 91 670 08 32



Deutschland

Wiesenstrasse 21 W
D40549 Düsseldorf,
Germany

 +49 (0) 211 506 6670
 +49 (0) 211 506 66799
 info@optoma.de

Scandinavia



Lerpeveien 25
3040 Drammen
Norway

 +47 32 98 89 90
 +47 32 98 89 99
 info@optoma.no

PO.BOX 9515
3038 Drammen
Norway

Korea

WOOMI TECH.CO.,LTD.
4F, Minu Bldg.33-14, Kangnam-Ku,
Seoul,135-815, KOREA
korea.optoma.com

 +82+2+34430004
 +82+2+34430005



Japan

東京都足立区綾瀬3-25-18
株式会社オーエス
コンタクトセンター:0120-380-495

 info@os-worldwide.com
www.os-worldwide.com



Taiwan

12F., No.213, Sec. 3, Beixin Rd.,
Xindian Dist., New Taipei City 231,
Taiwan, R.O.C.
www.optoma.com.tw

 +886-2-8911-8600
 +886-2-8911-6550
 services@optoma.com.tw
asia.optoma.com



Hong Kong

Unit A, 27/F Dragon Centre,
79 Wing Hong Street,
Cheung Sha Wan,
Kowloon, Hong Kong

 +852-2396-8968
 +852-2370-1222
www.optoma.com.hk

China

5F, No. 1205, Kaixuan Rd.,
Changning District
Shanghai, 200052, China

 +86-21-62947376
 +86-21-62947375
www.optoma.com.cn

